

Video Cassette Recorder

Operating Instructions

If you have any questions about this product, you may call: **Sony Customer Information Services Center** 1-800-222-SONY (7669) or write to: **Sony Customer Information Services Center** 6900-29 Daniels Parkway, PMB 330, Fort Myers, FL 33912

Declaration of Conformity

Trade Name: SONY
Model No.: SLV-N81/N71
Responsible Party: Sony Electronics Inc.
Address: 1 Sony Drive, Park Ridge, NJ.07656 USA
Telephone No.: 201-930-6972

This device complies with Part 15 of the FCC Rules. Operation is subject to the following two conditions: (1) This device may not cause harmful interference, and (2) this device must accept any interference received, including interference that may cause undesired operation.



SLV-N81



SLV-N71



WARNING

To prevent fire or shock hazard, do not expose the unit to rain or moisture.

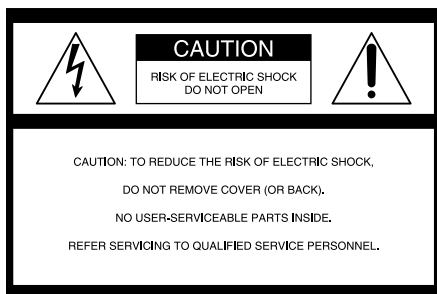

This symbol is intended to alert the user to the presence of uninsulated “dangerous voltage” within the product’s enclosure that may be of sufficient magnitude to constitute a risk of electric shock to persons.



This symbol is intended to alert the user to the presence of important operating and maintenance (servicing) instructions in the literature accompanying the appliance.

CAUTION

To prevent electric shock, do not use this polarized AC plug with an extension cord, receptacle or other outlet unless the blades can be fully inserted to prevent blade exposure.

Precautions

Safety

- Operate the unit only on 120 V AC, 60 Hz.
- If anything falls into the cabinet, unplug the unit and have it checked by qualified personnel before operating it any further.
- This unit is not disconnected from the AC power source (mains) as long as it is connected to the wall outlet, even if the unit itself has been turned off.
- Unplug the unit from the wall outlet if you do not intend to use it for an extended period of time. To disconnect the cord, pull it out by the plug, never by the cord.
- One blade of the plug is wider than the other for the purpose of safety and will fit into the power outlet only one way. If you are unable to insert the plug fully into the outlet, contact your Sony dealer.

Installing

- Allow adequate air circulation to prevent internal heat buildup.
- Do not place the unit on surfaces (rugs, blankets, etc.) or near materials (curtains, draperies) that may block the ventilation slots.

- Do not install the unit near heat sources such as radiators or air ducts, or in a place subject to direct sunlight, excessive dust, mechanical vibration or shock.
- Do not install the unit in an inclined position. It is designed to be operated in a horizontal position only.
- Keep the unit and cassettes away from equipment with strong magnets, such as microwave ovens or large loudspeakers.
- Do not place heavy objects on the unit.
- If the unit is brought directly from a cold to a warm location, moisture may condense inside the VCR and cause damage to the video head and tape. When you first install the unit, or when you move it from a cold to a warm location, wait for about three hours before operating the unit.

Information

For customers in the USA

CAUTION

You are cautioned that any changes or modifications not expressly approved in this manual could void your authority to operate this equipment.

NOTE:

This equipment has been tested and found to comply with the limits for a Class B digital device, pursuant to Part 15 of the FCC Rules.

These limits are designed to provide reasonable protection against harmful interference in a residential installation.

This equipment generates, uses, and can radiate radio frequency energy and, if not installed and used in accordance with the instructions, may cause harmful interference to radio communications.

However, there is no guarantee that interference will not occur in a particular installation. If this equipment does cause harmful interference to radio or television reception, which can be determined by turning the equipment off and on, the user is encouraged to try to correct the interference by one or more of the following measures:

- Reorient or relocate the receiving antenna.
- Increase the separation between the equipment and receiver.
- Connect the equipment into an outlet on a circuit different from that to which the receiver is connected.
- Consult the dealer or an experienced radio/TV technician for help.

Owner's record

The model and serial numbers are located at the rear of the unit.

Record these numbers in the spaces provided below. Refer to them whenever you call upon your Sony dealer regarding this product.

Model No. _____

Serial No. _____

Important Safeguards

For your protection, please read these safety instructions completely before operating the appliance, and keep this manual for future reference. Carefully observe all warnings, precautions and instructions on the appliance, or the one described in the operating instructions and adhere to them.

Use

Power sources

This set should be operated only from the type of power source indicated on the marking label. If you are not sure of the type of electrical power supplied to your home, consult your dealer or local power company. For those sets designed to operate from battery power, or other sources, refer to the operating instructions.



Grounding or Polarization

This set is equipped with a polarized ac power cord plug (a plug having one blade wider than the other), or with a three-wire grounding type plug (a plug having a third pin for grounding). Follow the instructions below:

For the set with a polarized ac power cord plug:

This plug will fit into the power outlet only one way. This is a safety feature. If you are unable to insert the plug fully into the outlet, try reversing the plug. If the plug should still fail to fit, contact your electrician to have a suitable outlet installed. Do not defeat the safety purpose of the polarized plug by forcing it in.



For the set with a three-wire grounding type ac plug:

This plug will only fit into a grounding-type power outlet. This is a safety feature. If you are unable to insert the plug into the outlet, contact your electrician to have a suitable outlet installed. Do not defeat the safety purpose of the grounding plug.

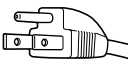

Overloading

Do not overload wall outlets, extension cords or convenience receptacles beyond their capacity, since this can result in fire or electric shock.

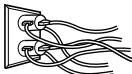

Object and Liquid Entry

Never push objects of any kind into the set through openings as they may touch dangerous voltage points or short out parts that could result in a fire or electric shock. Never spill liquid of any kind on the set.



Attachments

Do not use attachments not recommended by the manufacturer, as they may cause hazards.



Cleaning

Unplug the set from the wall outlet before cleaning or polishing it. Do not use liquid cleaners or aerosol cleaners. Use a cloth lightly dampened with water for cleaning the exterior of the set.



Installation

Water and Moisture

Do not use power-line operated sets near water - for example, near a bathtub, washbowl, kitchen sink, or laundry tub, in a wet basement, or near a swimming pool, etc.



Power-Cord Protection

Route the power cord so that it is not likely to be walked on or pinched by items placed upon or against them, paying particular attention to the plugs, receptacles, and the point where the cord exits from the appliance.

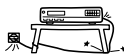

Accessories

Do not place the set on an unstable cart, stand, tripod, bracket, or table. The set may fall, causing serious injury to a child or an adult, and serious damage to the set. Use only a cart stand tripod, bracket, or table recommended by the manufacturer.



An appliance and cart combination should be moved with care. Quick stops, excessive force, and uneven surfaces may cause the appliance and cart combination to overturn.



Ventilation

The slots and openings in the cabinet are provided for necessary ventilation. To ensure reliable operation of the set, and to protect it from overheating, these slots and openings must never be blocked or covered.

- Never cover the slots and openings with a cloth or other materials.

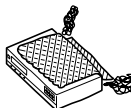

- Never block the slots and openings by placing the set on a bed, sofa, rug or other similar surface.



- Never place the set in a confined space, such as a bookcase, or built-in cabinet, unless proper ventilation is provided.
- Do not place the set near or over a radiator or heat register, or where it is exposed to direct sunlight.



Antennas

Outdoor antenna grounding

If an outdoor antenna or cable system is installed, follow the precautions below.

An outdoor antenna system should not be located in the vicinity of overhead power lines or other electric light or power circuits, or where it can come in contact with such power lines or circuits.

WHEN INSTALLING AN OUTDOOR ANTENNA SYSTEM, EXTREME CARE SHOULD BE TAKEN TO KEEP FROM CONTACTING SUCH POWER LINES OR CIRCUITS AS CONTACT WITH THEM IS ALMOST INVARIABLY FATAL.

Be sure the antenna system is grounded so as to provide some protection against voltage surges and built-up static charges. Section 810 of the National Electrical Code provides information with respect to proper grounding of the mast and supporting structure, grounding of the lead-in wire to an antenna discharge unit, size of grounding conductors, location of antenna-discharge unit, connection to grounding electrodes, and requirements for the grounding electrode.

Antenna Grounding According to the National Electrical Code

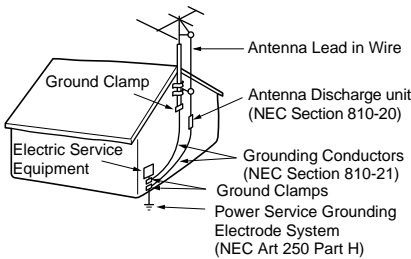

NEC-NATIONAL ELECTRICAL CODE

Lightning

For added protection for this set during a lightning storm, or when it is left unattended and unused for long periods of time, unplug it from the wall outlet and disconnect the antenna or cable system. This will prevent damage to the set due to lightning and power-line surges.

Service

Damage Requiring Service

Unplug the set from the wall outlet and refer servicing to qualified service personnel under the following conditions:

- When the power cord or plug is damaged or frayed.

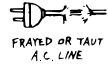

- If liquid has been spilled or objects have fallen into the set.



- If the set has been exposed to rain or water.



- If the set has been subject to excessive shock by being dropped, or the cabinet has been damaged.



- If the set does not operate normally when following the operating instructions. Adjust only those controls that are specified in the operating instructions. Improper adjustment of other controls may result in damage and will often require extensive work by a qualified technician to restore the set to normal operation.



- When the set exhibits a distinct change in performance - this indicates a need for service.

Servicing

Do not attempt to service the set yourself as opening or removing covers may expose you to dangerous voltage or other hazards.



Refer all servicing to qualified service personnel.

Replacement parts

When replacement parts are required, be sure the service technician has used replacement parts specified by the manufacturer that have the same characteristics as the original parts. Unauthorized substitutions may result in fire, electric shock, or other hazards.

Safety Check

Upon completion of any service or repairs to the set, ask the service technician to perform routine safety checks (as specified by the manufacturer) to determine that the set is in safe operating condition.



Table of contents

Getting Started

- 6 Step 1 : Unpacking
- 7 Step 2 : Setting up the remote commander
- 9 Step 3 : Hookups
- 27 Selecting a language
- 28 Setting the clock
- 35 Setting up the cable box control (SLV-N81 only)
- 41 Presetting channels
- 48 Setting up the VCR Plus+® GOLD system (SLV-N81 only)
- 55 Setting up the VCR Plus+® system (SLV-N71 only)

Basic Operations

- 59 Playing a tape
- 62 Recording TV programs
- 65 Recording TV programs using the Dial Timer
- 70 Recording TV programs using the VCR Plus+ or VCR Plus+ GOLD system
- 73 Setting the timer manually
- 76 Locking the VCR (Child Lock)
- 85 Searching for a selected point on the tape
- 87 Locating a channel by Station ID (SLV-N81 only)
- 88 Creating a favorite channel list with Station ID (SLV-N81 only)
- 90 Adjusting the picture
- 92 Changing menu options
- 94 Editing with another VCR

Additional Operations

- 77 Playing/searching at various speeds
- 79 Setting the recording duration time
- 80 Checking/changing/canceling timer settings
- 82 Recording stereo and bilingual programs
- 84 Searching using the index function

Additional Information

- 96 General setup information
- 98 Troubleshooting
- 100 Specifications
- 101 Index to parts and controls
- 106 Index

Back Cover

Quick reference to using the VCR

VCR Plus+, C³, ALLSET and PlusCode are trademarks of Gemstar Development Corporation. The VCR Plus+ system is manufactured under license from Gemstar Development Corporation.

Caution

Television programs, films, video tapes and other materials may be copyrighted.

Unauthorized recording of such material may be contrary to the provisions of the copyright laws. Also, use of this recorder with cable television transmission may require authorization from the cable television transmission and/or program owner.

Step 1 : Unpacking

Check that you have received the following items with the VCR:

- Remote commander
- 75-ohm coaxial cable with F-type connectors

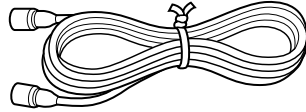
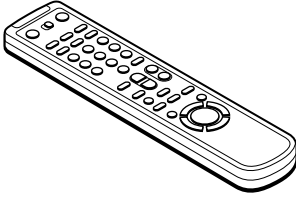

- Size AA (R6) batteries

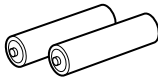

Check your model name

The instructions in this manual are for the 2 models: SLV-N81 and N71. Check your model name by looking at the rear panel of your VCR. SLV-N81 is the model used for illustration purposes. Any difference in operation is clearly indicated in the text, for example, "SLV-N81 only."

Step 2 : Setting up the remote commander

Inserting the batteries

Insert two size AA (R6) batteries by matching the + and – on the batteries to the diagram inside the battery compartment.

Insert the negative (–) end first, then push in and down until the positive (+) end clicks into position.

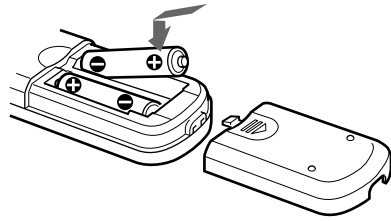

Using the remote commander

You can use this remote commander to operate this VCR and a Sony TV. Buttons on the remote commander marked with a dot (•) can be used to operate your Sony TV.

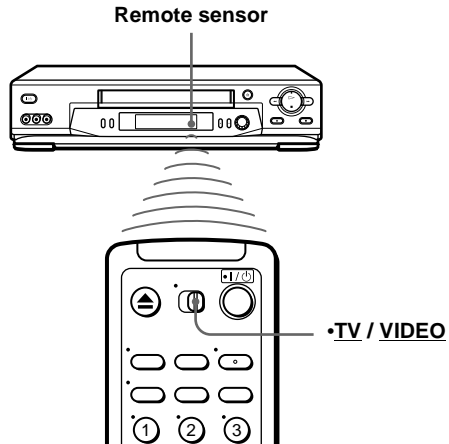

To operate	Set •TV / VIDEO to
the VCR	<u>VIDEO</u> and point at the remote sensor at the VCR
a Sony TV	•TV and point at the remote sensor at the TV

Notes

- With normal use, the batteries should last about three to six months.
- If you do not use the remote commander for an extended period of time, remove the batteries to avoid possible damage from battery leakage.
- Do not use a new battery with an old one.
- Do not use different types of batteries.

continued

Controlling other TVs with the remote commander

The remote commander is preprogrammed to control non-Sony TVs. If your TV is listed in the following table, set the appropriate manufacturer's code number.

- 1** Set **•TV / VIDEO** at the top of the remote commander to **•TV**.
- 2** Hold down **I/⏻**, and enter your TV's code number using the number buttons. Then release **I/⏻**.

Now you can use the **I/⏻**, **VOL +/-**, **CH +/-**, and **TV/VIDEO** buttons to control your TV. You can also use the buttons marked with a dot (•) to control a Sony TV. To control the VCR, reset **•TV / VIDEO** to **VIDEO**.

Code numbers of controllable TVs

If more than one code number is listed, try entering them one at a time until you find the one that works with your TV.

TV brand	Code number	TV brand	Code number	TV brand	Code number
Sony	01	JVC	09	RCA	04, 10
Akai	04	KMC	03	Sampo	12
AOC	04	Magnavox	03, 08, 12	Sanyo	11
Centurion	12	Marantz	04, 13	Scott	12
Coronado	03	MGA/Mitsubishi	04, 12, 13, 17	Sears	07, 10, 11
Curtis-Mathes	12	NEC	04, 12	Sharp	03, 05, 18
Daytron	12	Panasonic	06, 19	Sylvania	08, 12
Emerson	03, 04, 14	Philco	03, 04	Teknika	03, 08, 14
Fisher	11	Philips	08	Toshiba	07
General Electric	06, 10	Pioneer	16	Wards	03, 04, 12
Gold Star	03, 04, 17	Portland	03	Yorx	12
Hitachi	02, 03	Quasar	06, 18	Zenith	15
J.C.Penney	04, 12	Radio Shack	05, 14		

Notes

- If you enter a new code number, the code number previously entered will be erased.
- If the TV uses a different remote control system from the one programmed to work with the VCR, you cannot control your TV with the remote commander.
- When you replace the batteries of the remote commander, the code number may change. Set the appropriate code number every time you replace the batteries.
- When you press the AUDIO MONITOR button, your TV's menu may appear on the TV screen. To exit the TV menu, press the MENU button on the TV remote commander or wait until the menu disappears automatically.

Step 3 : Hookups

Selecting the best hookup option

There are many ways in which your VCR can be hooked up. To hook up your VCR so that it works best for you, first scan through the table below. Then use the accompanying diagrams and procedures on the following pages to set up your VCR.

If your TV has audio/video inputs, refer to pages 10 and 11 for audio/video (A/V) hookup. Then follow one of the hookups below. If your TV doesn't have A/V inputs, go directly to one of the hookups below.

For hookup 1 or 2, use the Sony RM-CM101 Cable Mouse (cable box controller) (not supplied). For details on obtaining a Cable Mouse controller, contact the Sony Customer Information Services Center.

For SLV-N81 only

If you have	Use	Refer to
A cable box that is compatible with the Cable Mouse	Hookup 1	Pages 12 to 14
A digital broadcast service's digital satellite receiver that is compatible with the Cable Mouse	Hookup 2	Pages 15 to 17

For both SLV-N81 and N71

If you have	Use	Refer to
No cable box or cable box with only a few scrambled channels	Hookup 3	Pages 18 to 20
Antenna only, no cable TV	Hookup 4	Pages 21 to 23
Cable box with many scrambled channels	Hookup 5	Pages 24 to 26

After you've completed the connections, follow the instructions for setup. During setup, if you need more details on the procedure described, page numbers are provided where you can find complete, step-by-step instructions.

After you've completed the setup, you're ready to use your VCR. Procedures differ depending on the hookup you used. For an overview, refer to "Quick reference to using the VCR" on the back cover.

Before you get started

- Turn off the power to all equipment.
- Do not connect the AC power cords until all of the connections are completed.
- Be sure to make connections firmly. Loose connections may cause picture distortion.
- If your TV doesn't match any of the examples provided, see your nearest Sony dealer or qualified technician.

Audio/video (A/V) hookup

If your TV has audio/video (A/V) input jacks, you will get a better picture and sound if you hook up your VCR using these connections. For a true “home theater” experience, you should connect the audio outputs of your VCR or TV to your stereo system. If your TV doesn’t have A/V inputs, see the following pages for antenna or cable hookups.

If your TV has the Control S function, hook up your VCR (SLV-N81 only) using the connection shown on page 11. This will allow you to operate your VCR by pointing your VCR’s remote commander at your TV.

If you’re not planning to use your VCR to record programs, you’re finished setting up the VCR after you’ve made the connections shown on pages 10 and 11. If you want to record regular or cable TV programs, complete these connections first, and then go to the following pages for antenna or cable hookups.

A Use this hookup if your TV has stereo jacks

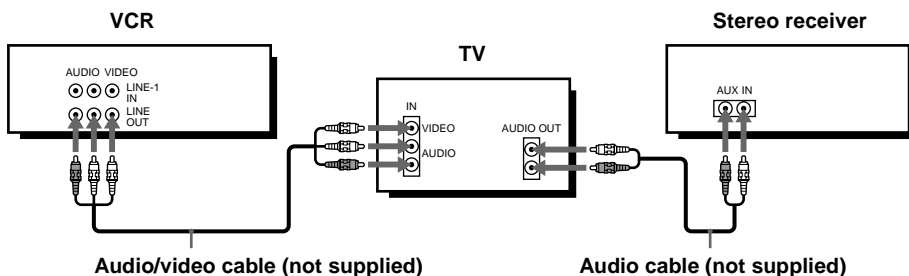

B Use this hookup if your TV doesn't have stereo jacks

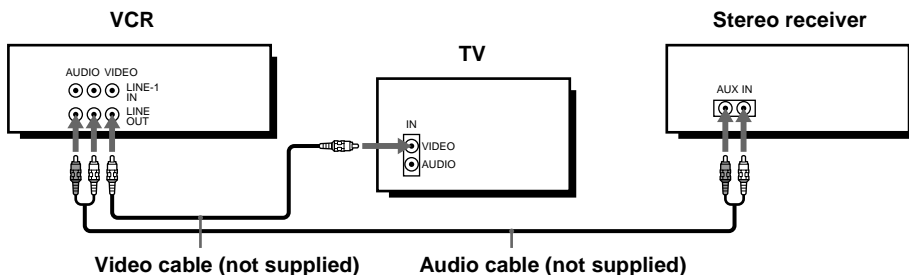

Note

- If you don't have a stereo receiver, connect the white LINE OUT/AUDIO L jack to the AUDIO IN jack on your TV.

Ⓢ Use this hookup if your TV has the Control S function (SLV-N81 only)

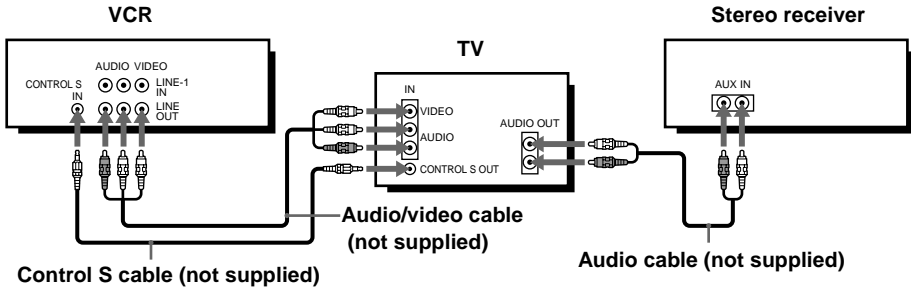

Notes

- To play a tape in stereo, you must use the A/V connection.
- Use the RK-G69 Control S cable (not supplied) for Control S connections.

Completing A/V hookup:

After you've connected your TV and completed antenna or cable hookup, return to this procedure to complete VCR set up. This will prevent unwanted noise in the RF channel.

Press MENU and select ADVANCED OPTIONS.

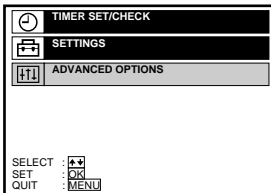

Set AUTO ANT SELECT to OFF and press OK.

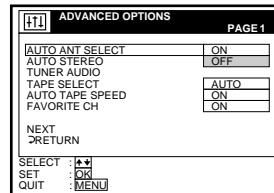

For details, see page 92.

Caution

Connections between the VCR's VHF/UHF connector and the antenna terminals of the TV receiver should be made only as shown in the following instructions. Failure to do so may result in operation that violates the regulations of the Federal Communications Commission regarding the use and operation of RF devices. Never connect the output of the VCR to an antenna or make simultaneous (parallel) antenna and VCR connections at the antenna terminals of your receiver.

Note to CATV system installer (in USA)

This reminder is provided to call the CATV system installer's attention to Article 820-40 of the NEC that provides guidelines for proper grounding and, in particular, specifies that the cable ground shall be connected to the grounding system of the building, as close to the point of cable entry as practical.

Hookup 1 (SLV-N81 only)

Using the cable box control feature

Recommended use

You should use this hookup if you have a cable box, especially if your cable system scrambles all or most channels. This hookup allows the VCR's cable box control feature to control the channels on the cable box, simplifying the recording process. A list of compatible cable boxes is on pages 37 and 38.

What you can do with this hookup

- Record any channel by using the Cable Mouse to select channels on the cable box

What you can't do

- Record with the cable box turned off
- Record one channel while watching another channel

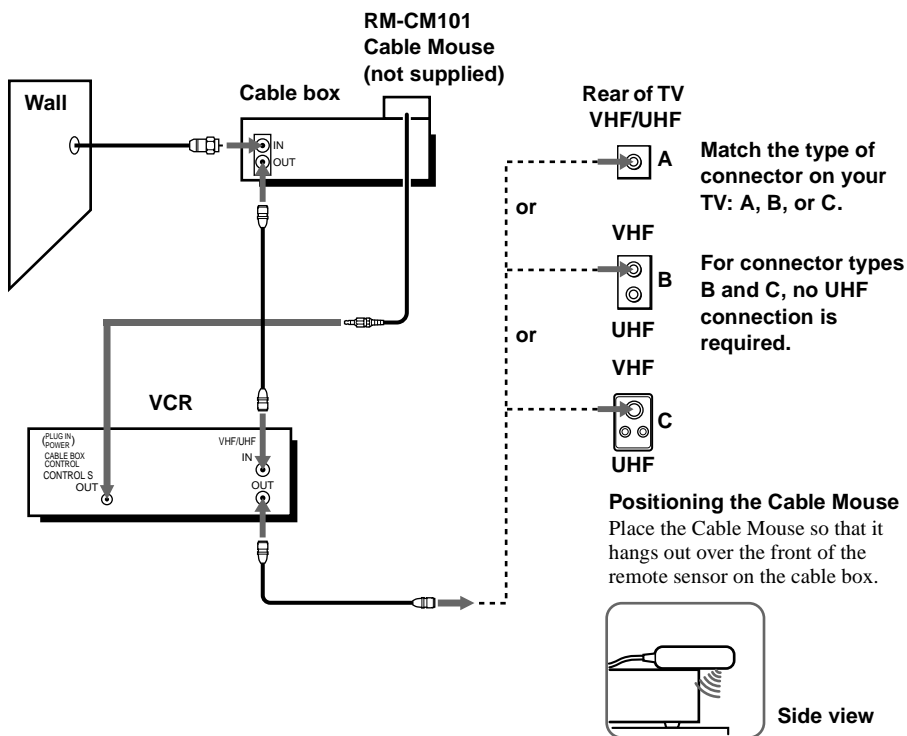

Hookup 1 : VCR setup

Before you start...

- Turn on the VCR and the TV.
- Press TV/VIDEO to display the VIDEO indicator in the VCR's display window.

- 1 Set the RF UNIT switch to CH3 or CH4, whichever channel is not used in your area. If both are used, set the switch to either channel. For details, see page 96.

If you made A/V connections (from page 10), you do not need to adjust the RF UNIT switch.

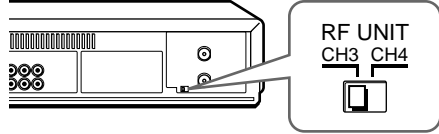

- 2 Turn on your cable box.
- 3 Press EASY SET UP on the VCR.

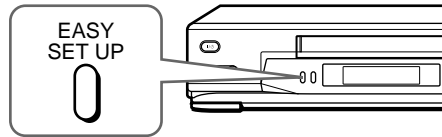

- 1 The LANGUAGE menu appears. Change the on-screen display language to Spanish (ESPAÑOL) or French (FRANÇAIS) if desired, and press OK. For details, see page 27.

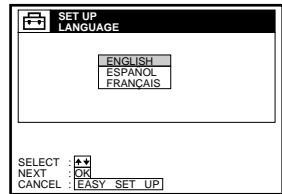

- 2 The CLOCK SET menu appears. Select AUTO and press OK. For details, see page 29.

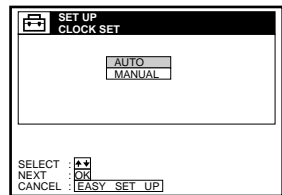

- 3 The SMART CHANNEL MAPPING menu appears. Press ↑/↓/←/→ to enter the ZIP/POSTAL CODE in your area and press OK. (You can also use the number buttons to enter the ZIP/POSTAL CODE.)

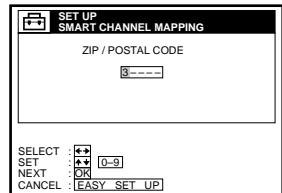

continued

- 4 The CABLE BOX CONTROL menu appears. Select ON. For details, see page 36.

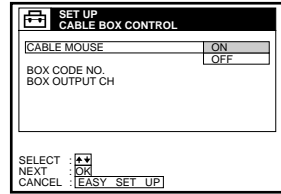

- 5 Enter your cable box code number and press OK. For details, see page 36.

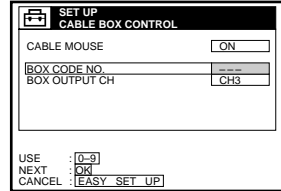

- 6 Select your cable box output channel and press OK.

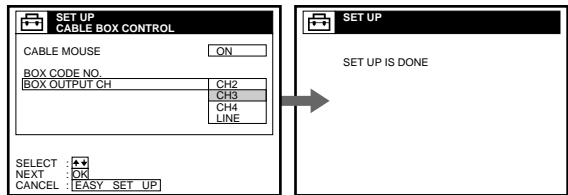

You have now completed hookup. If you want to use the VCR Plus+ GOLD system for recording, go to page 48 for VCR Plus+ GOLD system channel set up.

Automatic clock setting

Once you've set up the VCR, it automatically sets the clock the first time you turn off the VCR. "ACS" (Auto Clock Set) will flash in the display window and search for a time signal provided by some TV channels. After that, whenever you turn off the VCR, it checks the time and adjusts the clock, even for Daylight Saving Time.

If you want to use the timer to record right away, or if the channels in your area do not carry time signals, set the clock manually. For details, see page 33.

Notes

- To use the Auto Clock Set feature, leave the cable box on.
- If the clock is not set, "ACS" will flash in the display window whenever the VCR is turned off. During this time, the VCR will search for a time signal.

Hookup 2 (SLV-N81 only)

Connecting to a digital satellite receiver

Recommended use

Use this hookup if you have a digital satellite receiver that is compatible with the Cable Mouse. It allows the VCR's cable box control feature to control the channel on the digital satellite receiver, simplifying the recording process. A list of compatible digital satellite receivers is on page 39.

What you can do with this hookup

- Record any channels by using the Cable Mouse to select channels on the digital satellite receiver

What you can't do

- Record with the digital satellite receiver turned off
- Record any channels from cable or an antenna (To record channels from cable or an antenna, turn off the cable box control feature.)
- Use a cable box
- Record programs with the VCR Plus+ GOLD system (To use the VCR Plus+ GOLD system, turn off the cable box control feature.)

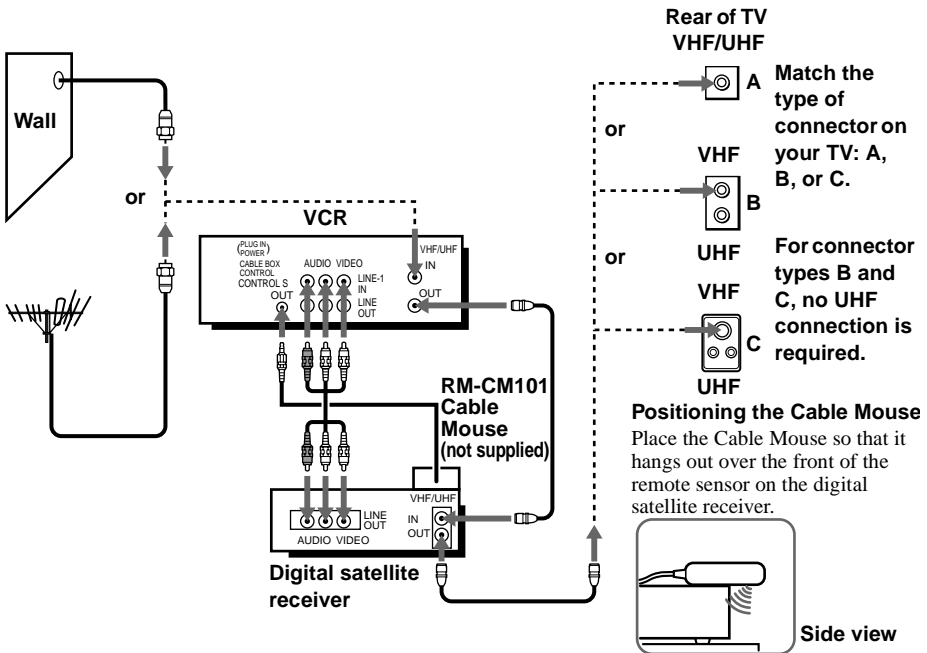

continued

Hookup 2 : VCR setup

Before you start...

- Turn on the VCR and the TV.
- Press TV/VIDEO to display the VIDEO indicator in the VCR's display window.

- 1** Set the RF UNIT switch to CH3 or CH4, whichever channel is not used in your area. If both are used, set the switch to either channel. For details, see page 96.

If you made A/V connections (from page 10), you do not need to adjust the RF UNIT switch.

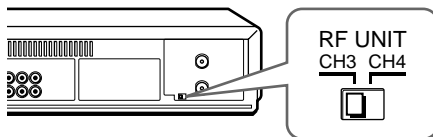

- 2** Turn on your digital satellite receiver.

- 3** Press EASY SET UP on the VCR.

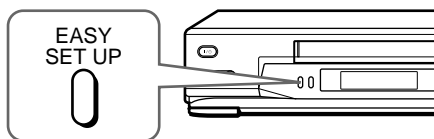

- 1** The LANGUAGE menu appears. Change the on-screen display language to Spanish (ESPAÑOL) or French (FRANÇAIS) if desired, and press OK. For details, see page 27.

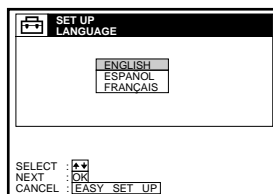

- 2** The CLOCK SET menu appears. Select AUTO and press OK. For details, see page 29.

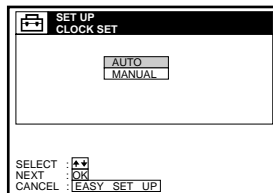

- 3** The SMART CHANNEL MAPPING menu appears. Press **↑/↓/←/→** to enter the ZIP/POSTAL CODE in your area and press OK. (You can also use the number buttons to enter the ZIP/POSTAL CODE.)

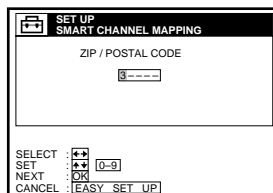

- 4 The CABLE BOX CONTROL menu appears. Select ON. For details, see page 36.

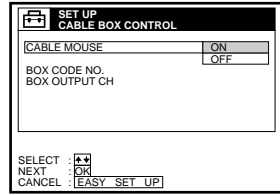

- 5 Enter your digital satellite receiver code number and press OK. For details, see page 36.

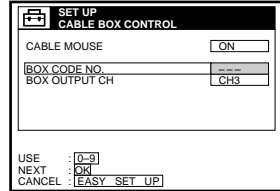

- 6 Set your digital satellite receiver output channel (BOX OUTPUT CH) to LINE and press OK.

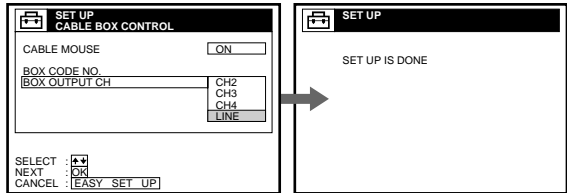

You have now completed hookup.

Automatic clock setting

Once you've set up the VCR, it automatically sets the clock the first time you turn off the VCR. "ACS" (Auto Clock Set) will flash in the display window and search for a time signal provided by some TV channels. After that, whenever you turn off the VCR, it checks the time and adjusts the clock, even for Daylight Saving Time.

If you want to use the timer to record right away, or if the channels in your area do not carry time signals, set the clock manually. For details, see page 33.

Notes

- If the clock is not set, "ACS" will flash in the display window whenever the VCR is turned off. During this time, the VCR will search for a time signal.
- To successfully record a program from the digital satellite receiver, proceed as follows:
 - Leave the digital satellite receiver on all the time.
 - Turn off the display (menu screen, channel number, etc.) of the digital satellite receiver.
 - To record or receive locked channels, unlock the channel before the VCR starts recording.
 - To set pay-per-view programs in the timer setting, order the pay-per-view program before the VCR starts recording.
 - Some programs are copy protected. You cannot record these programs.

Hookup 3

You have no cable box, or a cable box with only a few scrambled channels

Recommended use

Use this hookup if you do not have a cable box. Also use this hookup if your cable system scrambles only a few channels.

What you can do with this hookup

- Record any unscrambled channel by selecting the channel on the VCR

What you can't do

- Record scrambled channels that require a cable box

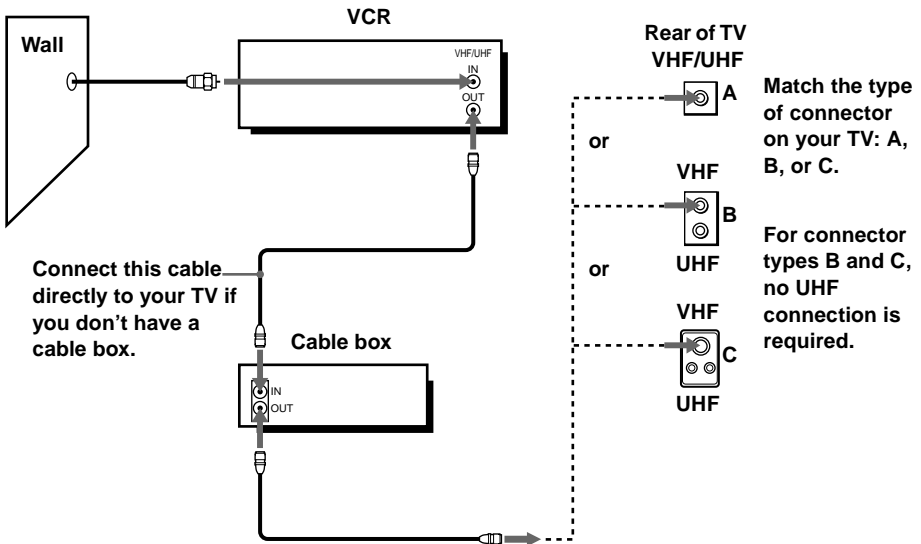

Hookup 3 : VCR setup

Before you start...

- Turn on the VCR and the TV.
- Press TV/VIDEO to display the VIDEO indicator in the VCR's display window.

- 1** Set the RF UNIT switch to CH3 or CH4, whichever channel is not used in your area. If both are used, set the switch to either channel. For details, see page 96.

If you made A/V connections (from page 10), you do not need to adjust the RF UNIT switch.

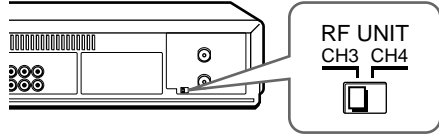

- 2** Press EASY SET UP on the VCR.

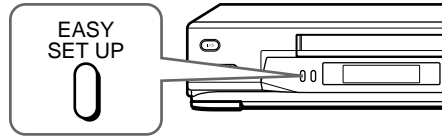

- 1** The LANGUAGE menu appears. Change the on-screen display language to Spanish (ESPAÑOL) or French (FRANÇAIS) if desired, and press OK. For details, see page 27.

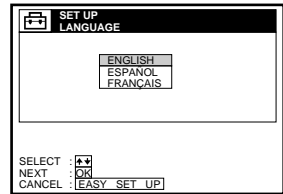

- 2** The CLOCK SET menu appears. Select AUTO and press OK. For details, see page 29.

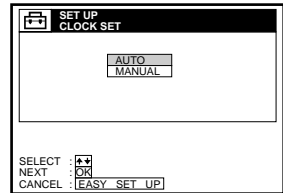

- 3** (For SLV-N81 only) The SMART CHANNEL MAPPING menu appears. Press **↑/↓/←/→** to enter the ZIP/POSTAL CODE in your area and press OK. (You can also use the number buttons to enter the ZIP/POSTAL CODE.)

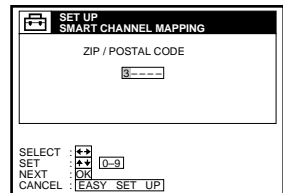

continued

- 4 (For SLV-N81 only)
The CABLE BOX CONTROL menu appears.
Select OFF and press OK.

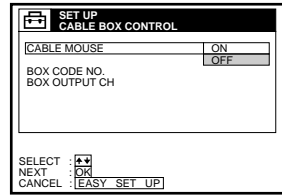

- 5 The TUNER PRESET menu appears. Set ANTENNA/CABLE to CABLE and press OK. For details, see page 42.

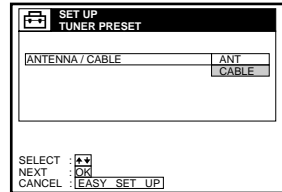

- 6 The AUTO PRESET starts.

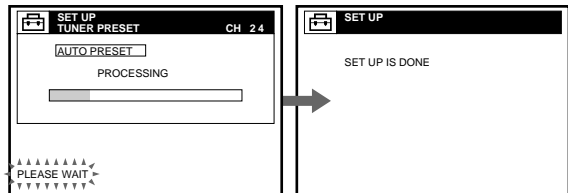

You have now completed hookup. If you want to use the VCR Plus+ or VCR Plus+ GOLD system for recording, go to the page listed below.

For SLV-N81: Go to page 48 for VCR Plus+ GOLD system channel set up.

For SLV-N71: Go to page 55 for VCR Plus+ system channel set up.

Automatic clock setting

Once you've set up the VCR, it automatically sets the clock the first time you turn off the VCR. "ACS" (Auto Clock Set) will flash in the display window and search for a time signal provided by some TV channels. After that, whenever you turn off the VCR, it checks the time and adjusts the clock, even for Daylight Saving Time.

If you want to use the timer to record right away, or if the channels in your area do not carry time signals, set the clock manually. For details, see page 33.

Note

- If the clock is not set, "ACS" will flash in the display window whenever the VCR is turned off. During this time, the VCR will search for a time signal.

Hookup 4

Antenna hookup

Make the following connections if you're using an antenna (if you don't have cable TV).

A Use this hookup if you're using:

- VHF/UHF antenna (you get channels 2–13 and channels 14 and higher)
- UHF-only antenna (you get channels 14 and higher)
- Separate VHF and UHF antennas

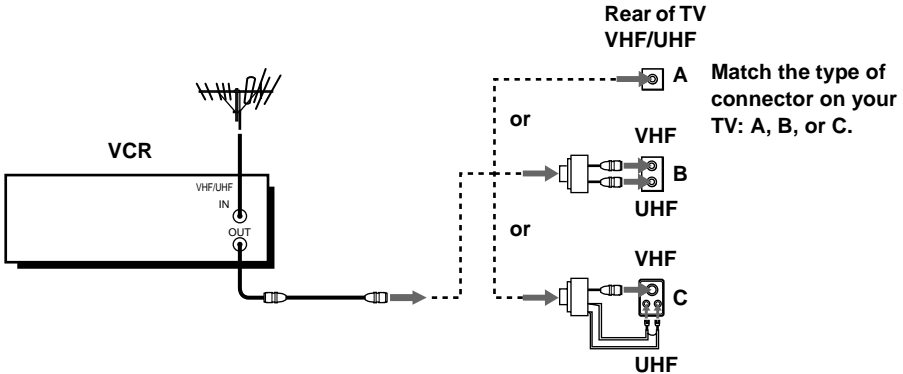

B Use this hookup if you're using a VHF-only antenna (you get channels 2–13 only)

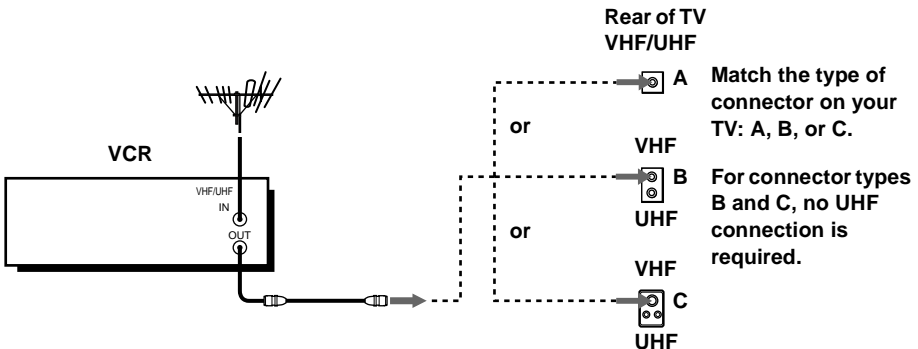

If you cannot connect your antenna cable to the VCR directly

If your antenna cable is a flat cable (300-ohm twin lead cable), attach an external antenna connector (not supplied) so you can connect the cable to the VHF/UHF IN connector. If you have separate cables for VHF and UHF antennas, you should use a U/V band mixer (not supplied). For details, see page 97.

continued

Hookup 4 : VCR setup

Before you start...

- Turn on the VCR and the TV.
- Press TV/VIDEO to display the VIDEO indicator in the VCR's display window.

- 1** Set the RF UNIT switch to CH3 or CH4, whichever channel is not used in your area. If both are used, set the switch to either channel. For details, see page 96.

If you made A/V connections (from page 10), you do not need to adjust the RF UNIT switch.

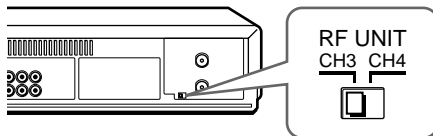

- 2** Press EASY SET UP on the VCR.

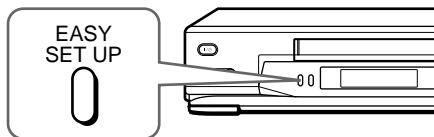

- 1** The LANGUAGE menu appears. Change the on-screen display language to Spanish (ESPAÑOL) or French (FRANÇAIS) if desired, and press OK. For details, see page 27.

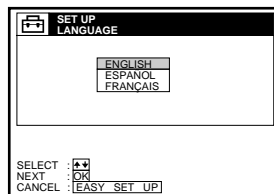

- 2** The CLOCK SET menu appears. Select AUTO and press OK. For details, see page 29.

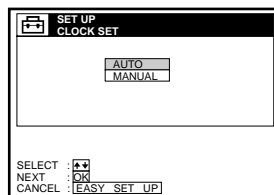

- 3** (For SLV-N81 only) The SMART CHANNEL MAPPING menu appears. Press $\uparrow/\downarrow/\leftarrow/\rightarrow$ to enter the ZIP/POSTAL CODE in your area and press OK. (You can also use the number buttons to enter the ZIP/POSTAL CODE.)

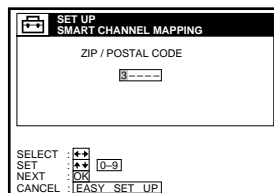

- 4 (For SLV-N81 only)
The CABLE BOX CONTROL menu appears.
Select OFF and press OK.

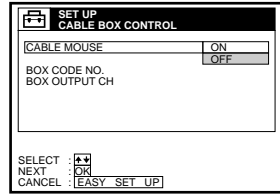

- 5 The TUNER PRESET menu appears. Set ANTENNA/CABLE to ANT and press OK.
For details, see page 42.

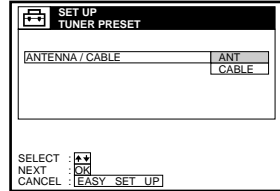

- 6 The AUTO PRESET starts.

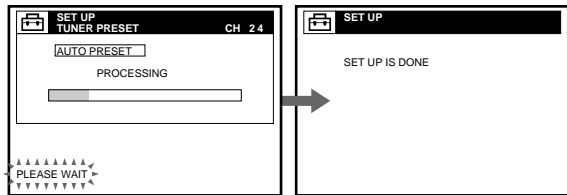

You have now completed hookup. If you want to use the VCR Plus+ or VCR Plus+ GOLD system for recording, go to the page listed below.

For SLV-N81: Go to page 48 for VCR Plus+ GOLD system channel set up.

For SLV-N71: Go to page 55 for VCR Plus+ system channel set up.

Automatic clock setting

Once you've set up the VCR, it automatically sets the clock the first time you turn off the VCR. "ACS" (Auto Clock Set) will flash in the display window and search for a time signal provided by some TV channels. After that, whenever you turn off the VCR, it checks the time and adjusts the clock, even for Daylight Saving Time.

If you want to use the timer to record right away, or if the channels in your area do not carry time signals, set the clock manually. For details, see page 33.

Note

- If the clock is not set, "ACS" will flash in the display window whenever the VCR is turned off. During this time, the VCR will search for a time signal.

Hookup 5

Connecting a cable box with many scrambled channels

Recommended use

Use this hookup if your cable system scrambles all or most channels.

What you can do with this hookup

- Record any channel by selecting the channel on the cable box

What you can't do

- Record with the cable box turned off
- Record one channel while watching another channel

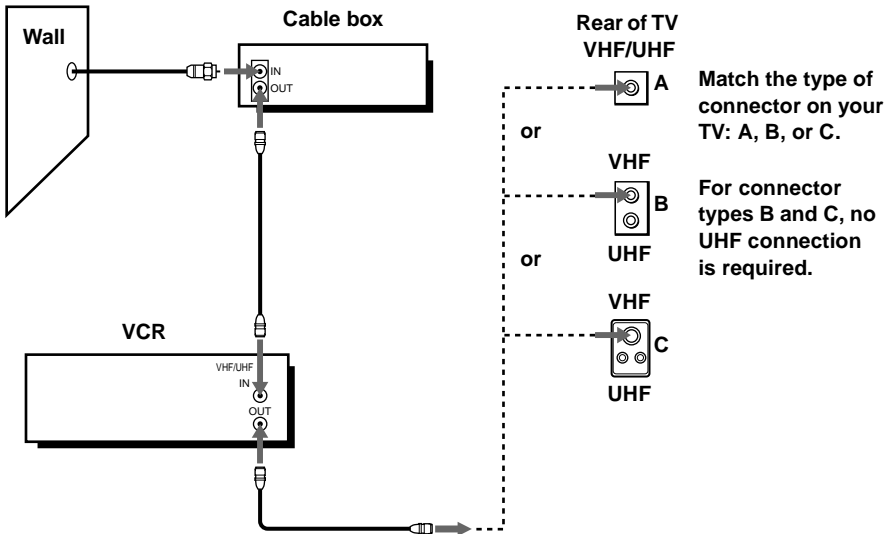

Hookup 5 : VCR setup

Before you start...

- Turn on the VCR and the TV.
- Press TV/VIDEO to display the VIDEO indicator in the VCR's display window.

- 1 Set the RF UNIT switch to CH3 or CH4, whichever channel is not used in your area. If both are used, set the switch to either channel. For details, see page 96.

If you made A/V connections (from page 10), you do not need to adjust the RF UNIT switch.

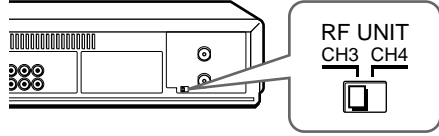

- 2 Turn on your cable box.
- 3 Press EASY SET UP on the VCR.

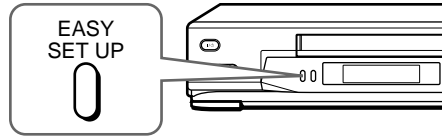

- 1 The LANGUAGE menu appears. Change the on-screen display language to Spanish (ESPAÑOL) or French (FRANÇAIS) if desired, and press OK. For details, see page 27.

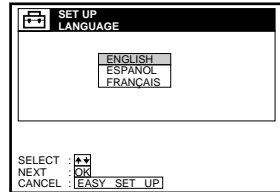

- 2 The CLOCK SET menu appears. Select MANUAL and press OK. Then set the clock manually and press OK. For details, see page 34.

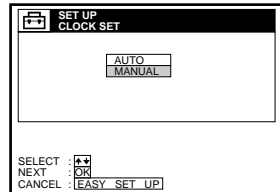

- 3 (For SLV-N81 only) The SMART CHANNEL MAPPING menu appears. Press $\uparrow/\downarrow/\leftarrow/\rightarrow$ to enter the ZIP/POSTAL CODE in your area and press OK. (You can also use the number buttons to enter the ZIP/POSTAL CODE.)

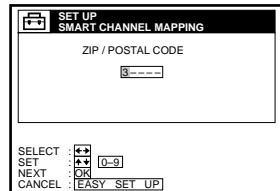

continued

- 4 (For SLV-N81 only)
The CABLE BOX CONTROL menu appears.
Select OFF and press OK.

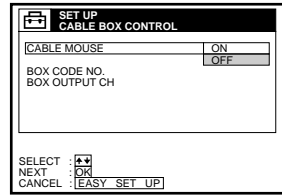

- 5 The TUNER PRESET menu appears. Set ANTENNA/CABLE to ANT and press OK.
For details, see page 42.

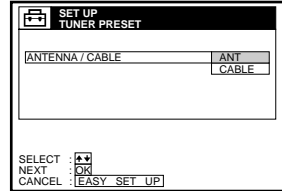

- 6 The AUTO PRESET starts.

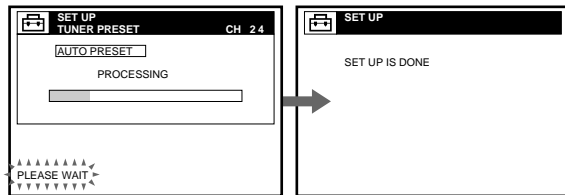

You have now completed hookup. If you want to use the VCR Plus+ or VCR Plus+ GOLD system for recording, go to the pages listed below.

For SLV-N81: Find the VCR Plus+ GOLD system Channel Listing in your program guide. For details, see page 48. Then enter all channels you want to record and the cable box output channel (usually 2, 3, or 4) as described on page 52.

For SLV-N71: Go to page 55 for VCR Plus+ system channel set up.

Automatic clock setting

Once you've set up the VCR, it automatically sets the clock the first time you turn off the VCR. "ACS" (Auto Clock Set) will flash in the display window and search for a time signal provided by some TV channels. After that, whenever you turn off the VCR, it checks the time and adjusts the clock, even for Daylight Saving Time.

To use the Auto Clock Set feature with this hookup, you need to manually select a channel that carries a time signal:

- 1 Tune the cable box to a channel that carries a time signal.
- 2 Select AUTO in the CLOCK SET menu to turn on the Auto Clock Set feature.
- 3 Turn off the VCR. It automatically sets the clock and adjusts for Daylight Saving Time by picking up the time signal.

If you want to use the timer to record right away, or if the channels in your area do not carry time signals, set the clock manually. For details, see page 33.

Notes

- To use the Auto Clock Set feature, leave the cable box on.
- If the clock is not set, "ACS" will flash in the display window whenever the VCR is turned off. During this time, the VCR will search for a time signal.

Selecting a language

You can change the on-screen display language.

Before you start...

- Turn on the VCR and the TV.
- Set the TV to the VCR channel (channel 3 or 4). If your TV is connected to the VCR using A/V connections, set the TV to video input.
- Press TV/VIDEO to display the VIDEO indicator in the VCR's display window.

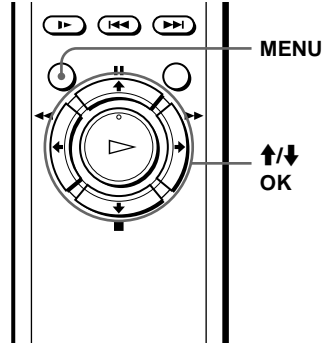

- 1** Press MENU, then press **↑/↓** to highlight **SETTINGS** and press OK.



When using the EASY SET UP procedure, skip steps 1 and 2.

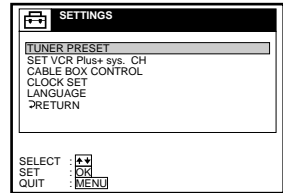

- 2** Press **↑/↓** to highlight **LANGUAGE**, then press OK.

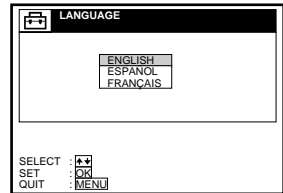

- 3** Press **↑/↓** to highlight **ENGLISH**, **ESPAÑOL**, or **FRANÇAIS**, then press OK.



Tip

- If you want to return to the previous menu, highlight **RETURN** and press OK.

Setting the clock

Using the Auto Clock Set feature

Some TV and cable channels transmit time signals with their broadcasts. Your VCR can pick up this time signal to automatically set the clock.

The Auto Clock Set feature works only if a channel in your area is broadcasting a time signal. If broadcasters in your area are not yet sending time signals, set the time manually (page 33).

Before you start...

- Turn on the VCR and the TV.
- Set the TV to the VCR channel (channel 3 or 4). If your TV is connected to the VCR using A/V connections, set the TV to video input.
- Press TV/VIDEO to display the VIDEO indicator in the VCR's display window.

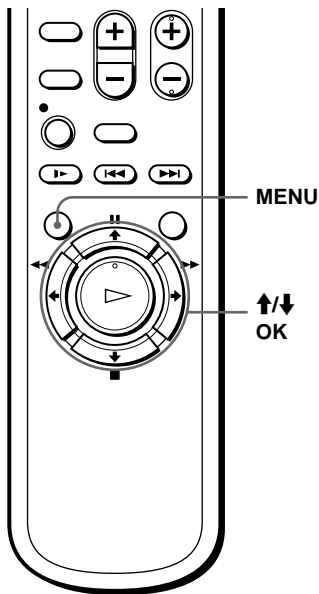

1

MENU

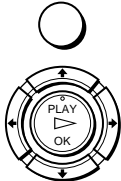

Press MENU, then press \uparrow/\downarrow to highlight SETTINGS and press OK.

When using the EASY SET UP procedure, skip steps 1 and 2.

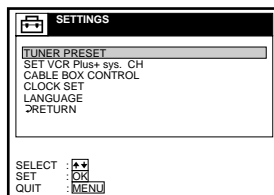

2



Press \uparrow/\downarrow to highlight CLOCK SET, then press OK.

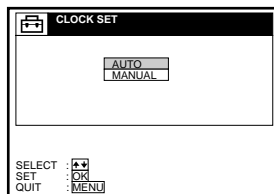

3



Press **↑/↓** to highlight AUTO, then press OK.

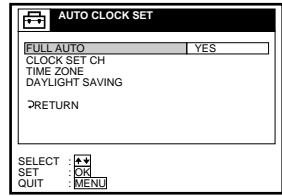

4



Press **↑/↓** to highlight FULL AUTO, then press OK.

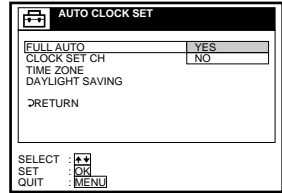

5



Press **↑/↓** to highlight YES, then press OK.

6



Press MENU to exit the menu.

7

To activate the Auto Clock Set function, turn off the VCR. “ACS” will flash in the display window.

The VCR automatically sets the clock by searching for a channel that carries a time signal and sets your time zone and Daylight Saving Time (if applicable).

If your clock is set to the wrong time zone or Daylight Saving Time, you can adjust these settings without turning off the Auto Clock Set feature (page 30).

Tip

- If you want to return to the previous menu, highlight RETURN and press OK.

Notes

- The clock cannot be set automatically if you don't receive a channel that carries a time signal in your area. If so, set the clock manually (see page 33).
- If there are only a few channels in your area that carry time signals, setting the clock automatically may take up to about 30 minutes. If nothing happens even after you wait about 30 minutes, set the clock manually.
- If you use Hookup 1 or 5, make sure you leave the cable box on.
- If the clock is not set, “ACS” will flash in the display window whenever the VCR is turned off. During this time, the VCR will search for a time signal.

continued

If the clock does not activate

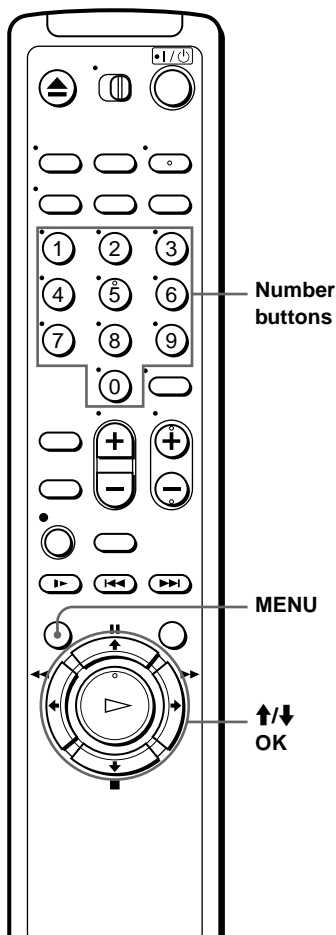

1

Follow steps 1 to 4 in “Using the Auto Clock Set feature.”

The AUTO CLOCK SET menu is displayed.

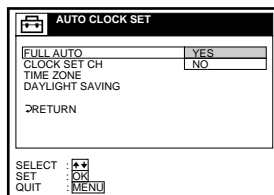

2



Press **↑/↓** to highlight NO for FULL AUTO and press OK.

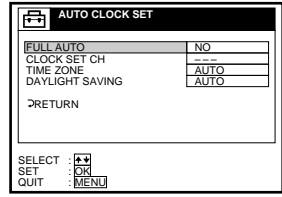

3



Press **↑/↓** to highlight the item you want to set and press OK. Then press **↑/↓** to make the setting and press OK.

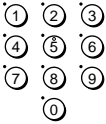

- For **CLOCK SET CH**
Leave the setting to “---” to have the VCR automatically search for a channel that carries a time signal. Press the number buttons to select a channel that carries a time signal. Use this option if you know of a channel that carries a time signal. Most PBS member stations broadcast a time signal. For the fastest response, select your local PBS station.

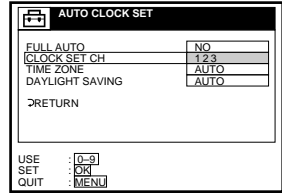

- For **TIME ZONE**
Select the time zone of your area, or select AUTO to have the VCR automatically set your time zone. The options are:
AUTO ↔ ATLANTIC ↔ EASTERN
↔ CENTRAL ↔ MOUNTAIN ↔
PACIFIC ↔ ALASKA ↔ HAWAII
↔ AUTO
- For **DAYLIGHT SAVING**
Select ON or OFF (standard time), or AUTO to have the VCR automatically set the daylight saving time.

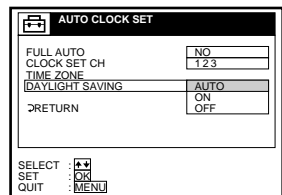
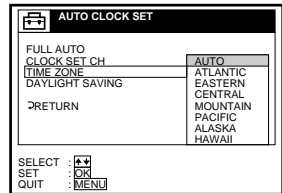

4

MENU



Press MENU to exit the menu.

5

To activate the Auto Clock Set function, turn off the VCR. “ACS” will flash in the display window.

continued

Tip

- If you want to return to the previous menu, highlight RETURN and press OK.

Note

- (SLV-N81 only)

If you use both the cable box control feature and the Auto Clock Set feature, the VCR automatically changes channels on the cable box until a channel that carries a time signal is found whenever you turn off the VCR.

If you want to stop the search, change the channel on the cable box with the channel buttons either on the VCR or on the remote commander.

Using Manual Clock Set

Before you start...

- Turn on the VCR and the TV.
- Set the TV to the VCR channel (channel 3 or 4). If your TV is connected to the VCR using A/V connections, set the TV to video input.
- Press TV/VIDEO to display the VIDEO indicator in the VCR's display window.

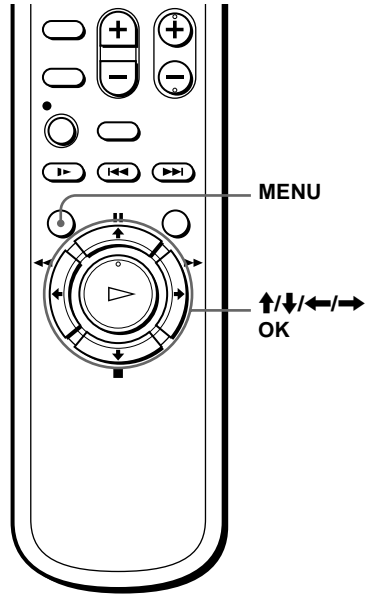

1

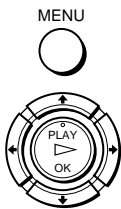

Press MENU, then press \uparrow/\downarrow to highlight SETTINGS and press OK.

When using the EASY SET UP procedure, skip steps 1 and 2.

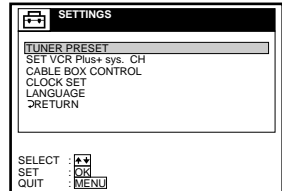

2



Press \uparrow/\downarrow to highlight CLOCK SET, then press OK.

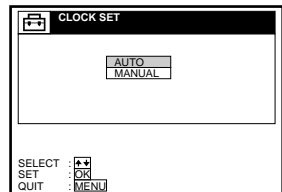

continued

3



Press **↑/↓** to highlight MANUAL, then press OK.

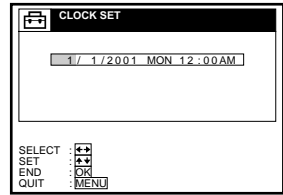

4



Press **↑/↓** to set the month.

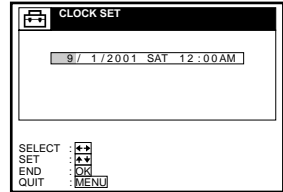

5



Press **→** to highlight the day and press **↑/↓** to set the day.

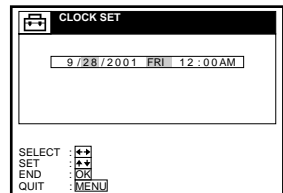

6

Set the year, hour, and minutes in the same way as the day.
The day of the week is set automatically.

7



Press OK to start the clock.

Tip

- If you want to return to the previous menu, highlight RETURN and press OK.

Setting up the cable box control (SLV-N81 only)

(Skip this section if you are using Hookup 3, 4, or 5.)

Your VCR includes a cable box control feature that allows the VCR to control most brands of cable boxes or digital satellite receivers via an optional Cable Mouse. With the cable box control, the VCR controls channels on the cable box or digital satellite receiver for timer recording. You can also use the VCR's remote commander to change channels on the cable box or digital satellite receiver whenever the cable box or digital satellite receiver is turned on even if the VCR is turned off. To use cable box control, you need to connect the Sony RM-CM101 Cable Mouse (not supplied) (pages 12 and 15) and set the code number and output channel.

This VCR is programmed with codes necessary to control channel selection on most brands of cable boxes or digital satellite receivers at the time this VCR was manufactured. It is possible that new cable boxes may be introduced that cannot be controlled with the RM-CM101 Cable Mouse. If you have a cable box that is incompatible with this VCR, contact your cable operator — they may be able to provide you with a compatible cable box.

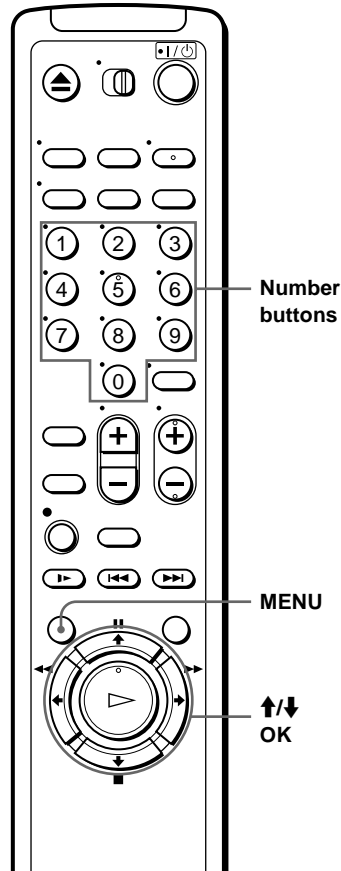

1

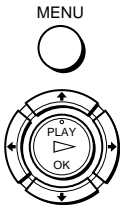

Press MENU, then press **↑/↓** to highlight SETTINGS and press OK.

When using the EASY SET UP procedure, skip steps 1 and 2.

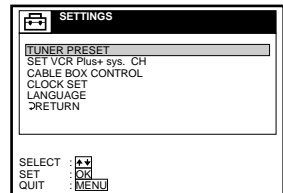

continued

2



Press **↑/↓** to highlight CABLE BOX CONTROL, then press OK.

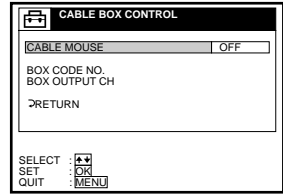

3



Press **↑/↓** to highlight CABLE MOUSE, then press OK.

4



Press **↑/↓** to highlight ON, then press OK.

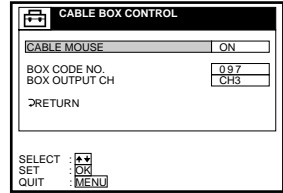

5



Press **↑/↓** to highlight BOX CODE NO., then press OK.

When BOX CODE NO. is “---,” skip this step.

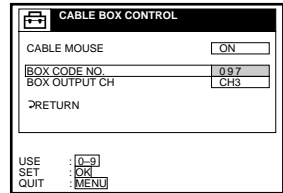

6

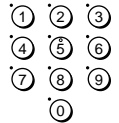

Press the number buttons to enter the cable box or digital satellite receiver code number, then press OK.

Find your cable box or digital satellite receiver code number from the following chart.

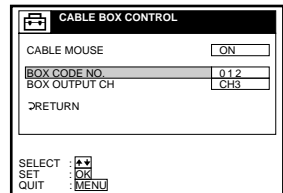

7



Press **↑/↓** to highlight BOX OUTPUT CH, then press OK.

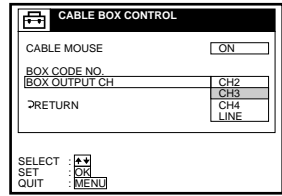

8



If you want to control a cable box, press **↑/↓** to highlight the cable box output channel, then press OK.

If you want to control a digital satellite receiver, select LINE, then press OK.

9

MENU



Press MENU to exit the menu.

Tip

- If you want to return to the previous menu, highlight RETURN and press OK.

Cable box and digital satellite receiver brands and the corresponding code numbers

If more than one code number is listed, try entering them one by one until you come to the correct code for your equipment.

Cable box brand	Code numbers
ABC	018, 022, 024, 028, 217
Antronix	218
Archer	033, 050, 164, 218, 808
BBT	278
Cable Star	067
Cabletenna	033
Cable time	172, 388, 459
Century	164
Citizen	164, 326, 327
Clyde Cablevision	097
Colour Voice	036, 042
Comband	243, 244
Comtronics	051, 071
Decsat	434

Cable box brand	Code numbers
Diamond	046
Eagle Comtronics	051
Eastern	013, 285
Electricord	089
Electus	055
Focus	411
Garrard	164
GC Electronics	027, 067, 341
GE	243, 244
GEC	097
Gemini	026, 068, 081
General Instrument	022, 287, 487
Hamlin	020, 031, 045, 270, 284
Hitachi	022
Jasco	164, 326

continued

Cable box brand	Code numbers
Jerrold	014, 022, 025, 026, 035, 037, 058, 109, 287, 487
Linsay	451
Macom	044
Magnavox	038, 043, 080
Memorex	011
Movie Time	089, 167, 214
Northcoast	325
Novaplex	629
NSC	074, 081, 167, 214
Oak	018, 030, 259
Panasonic	032, 118
Paragon	011
Philips	036, 038, 039, 040, 041, 042, 071, 301
Pioneer	034, 155, 271, 544, 695
Popular Mechanics	411
Pulsar	011
Radio shack	808
RCA	032
Realistic	218
Recoton	411
Regal	031, 270, 284, 290
Regency	013
Rembrandt	081
Samsung	051, 155
Scientific Atlanta	017, 019, 028, 288
Seam	521
Sharp	324
Signal	051
Signature	022
SL Marx	051
Spectravision	069

Cable box brand	Code numbers
Sprucer	032, 318
Standard Components	107, 166
Starcom	014, 026, 058, 109
Stargate	026, 051
STS	167
Sylvania	012
T-Cable Teletext	116
Tandy	269
Tatung	108
Teknica	157
TeleCaption	232
Teleservice	292
Texscan	012, 107
TFC	321
Timeless	429
Tocom	023, 024
Toshiba	011
Tudi	297
TV86	074
TV COM	018, 030, 259
Uniden	236
Unika	033, 164, 218
United Artists	018
United Cable	014
Universal	033, 050, 067, 088, 089, 164, 202, 218, 333
Videoway	261
Vidtech	255
Viewstar	038, 071, 074, 122, 222, 269, 300
Zenith	011, 065, 536
Zentek	411
Wave Master	576

Digital satellite receiver brand	Code numbers
Sony	650
Echo Star	786
HTS	786

Digital satellite receiver brand	Code numbers
Hughes Network Systems	760
Panasonic	712
RCA	577

To ensure correct operation

- Place the Cable Mouse so that it hangs out over the front of the remote sensor on the cable box or digital satellite receiver.
- Do not place the cable box or digital satellite receiver on top of the VCR.
- Position the cable box or digital satellite receiver away from the VCR.
- Point the remote commander at the VCR, not at the cable box or digital satellite receiver.

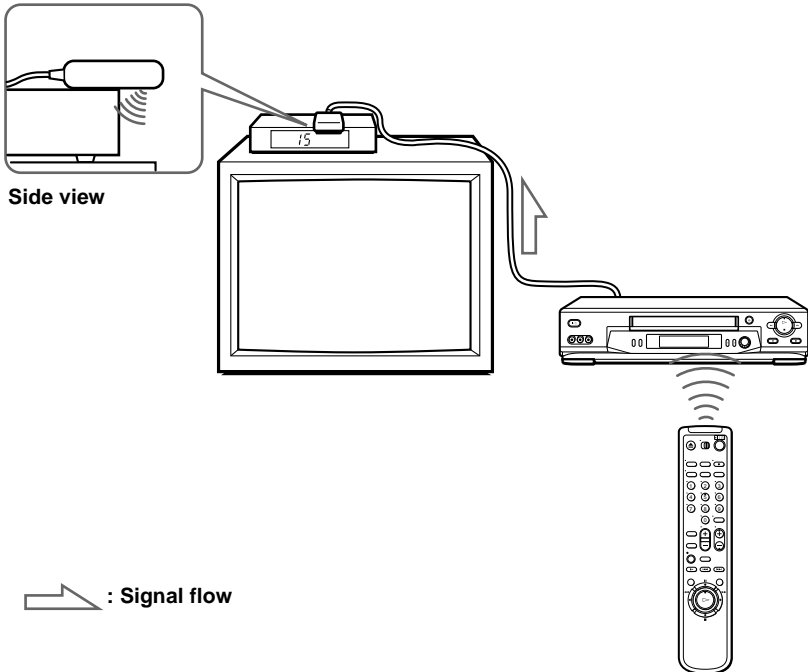

continued

To check the cable box control setting

- 1** Press CH +/- on the remote commander. Does the channel indicator on the cable box or digital satellite receiver change? (Point the remote commander at the VCR, not at the cable box or digital satellite receiver.)
- 2** Press all 10 number buttons (0 to 9) on the remote commander. Does the channel indicator on the cable box or digital satellite receiver change?

If the answer to both 1 and 2 is “yes,” you have made the correct setting.

If you cannot get your VCR to control the cable box or digital satellite receiver

- Check that the Cable Mouse is connected to the CABLE BOX CONTROL jack on the VCR.
- Check the position of the Cable Mouse.
- Place the cable box or digital satellite receiver and VCR away from each other. Do not place the cable box or digital satellite receiver on top of the VCR.
- Try the setup again making sure to use the correct control code. If the cable box still does not respond, try the other codes that are listed.

If your cable box still does not operate with the Cable Mouse, contact your cable company to see if they can provide you with a compatible cable box.

Note

- Make sure you turn off the VCR when you plug in or unplug the Cable Mouse. If you unplug the Cable Mouse and plug it in again, turn on the VCR before you use the cable box or digital satellite receiver control feature.

Presetting channels

(Skip this section if you are using a cable box or digital satellite receiver control.)

This VCR is capable of receiving VHF channels 2 to 13, UHF channels 14 to 69 and unscrambled CATV channels 1 to 125. First, we recommend that you preset the receivable channels in your area using automatic presetting methods. Then, if there are any unwanted channels, disable them manually. If you have already decided which channels you wish to preset, set them directly using manual presetting methods.

Before you start...

- Turn on the VCR and the TV.
- Set the TV to the VCR channel (channel 3 or 4). If your TV is connected to the VCR using A/V connections, set the TV to video input.
- Press TV/VIDEO to display the VIDEO indicator in the VCR's display window.

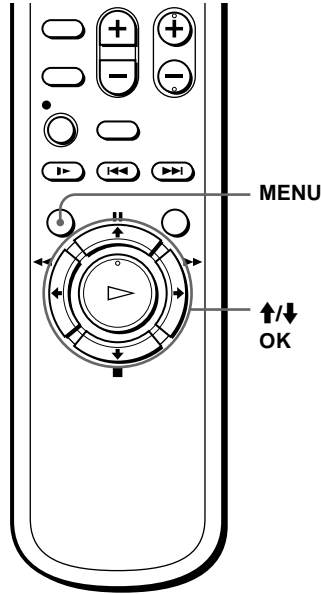

Presetting all receivable channels automatically

1

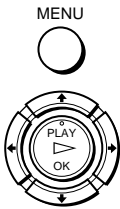

Press MENU, then press **↑/↓** to highlight **SETTINGS** and press OK.

When using the EASY SET UP procedure, skip steps 1 and 2.

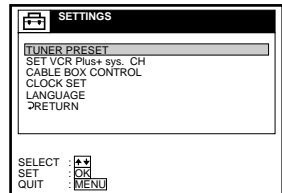

2



Press **↑/↓** to highlight **TUNER PRESET**, then press OK.

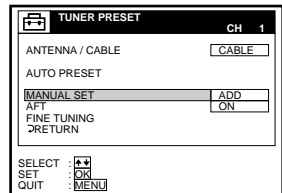

continued

3



Press **↑/↓** to highlight ANTENNA/CABLE, then press OK.

4



• To preset cable TV channels:
Press **↑/↓** to set ANTENNA/CABLE to CABLE, then press OK.

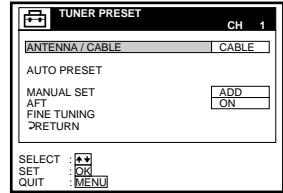

• To preset VHF and UHF channels:
Press **↑/↓** to set ANTENNA/CABLE to ANT, then press OK.

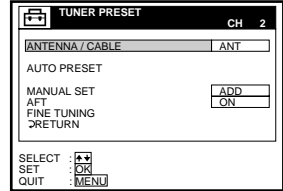

5



Press **↑/↓** to highlight AUTO PRESET, then press OK.

All receivable channels are preset in numerical sequence. When no more receivable channels can be found, presetting stops and the picture from the lowest numbered channel is displayed on the TV screen.

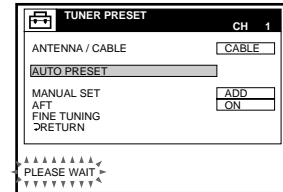

Tips

- When receiving a VHF, UHF, or CATV channel, the display changes as follows each time you press DISPLAY.

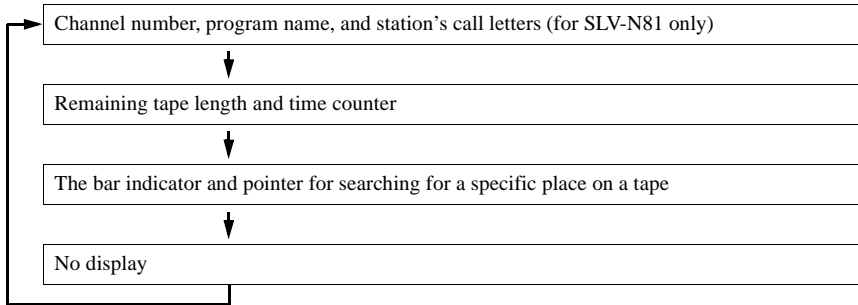

- If you want to return to the previous menu, highlight RETURN and press OK.

Presetting/disabling channels manually

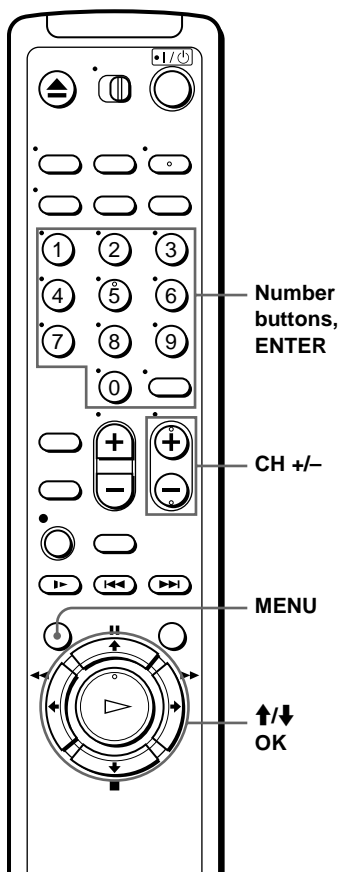

1

MENU

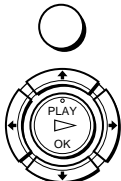

Press MENU, then press ↑/↓ to highlight SETTINGS and press OK.

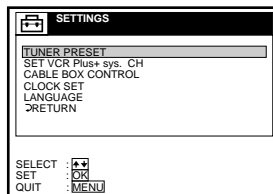

2

Press **↑/↓** to highlight TUNER PRESET, then press OK.

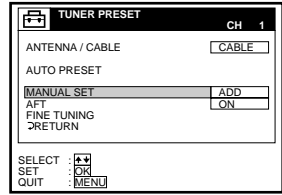
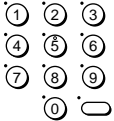
**3**

• To preset a channel:

- 1 Press the number buttons to enter the channel number, then press ENTER.
- 2 Press OK.
- 3 Press **↑/↓** to set MANUAL SET to ADD, then press OK.



• CH



• To disable a channel:

- 1 Press CH +/- to select the channel number.
- 2 Press OK.
- 3 Press **↑/↓** to set MANUAL SET to ERASE, then press OK.



Channel to be preset

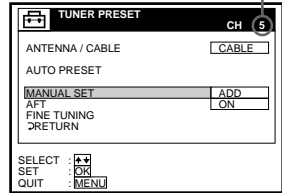

Channel to be disabled

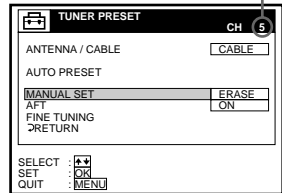
**4**

MENU



Repeat step 3 to preset or disable channels as required, then press MENU.

Tip

- If you want to return to the previous menu, highlight RETURN and press OK.

continued

If the picture is not clear

Normally, the Auto Fine Tuning (AFT) function automatically tunes in channels clearly. If, however, the picture of a channel is not clear, you can also use the manual tuning function.

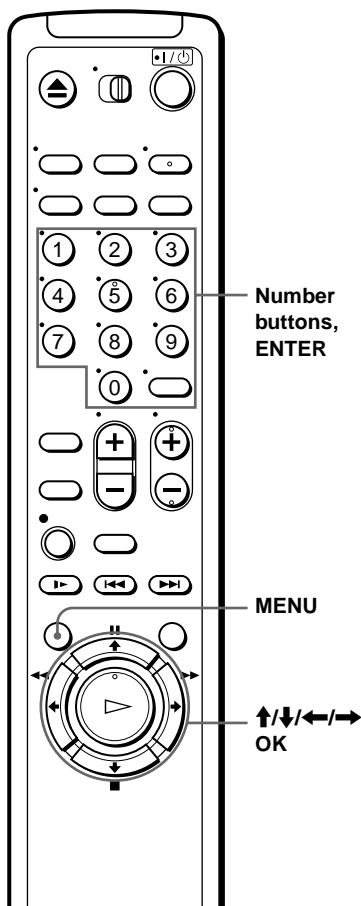

1

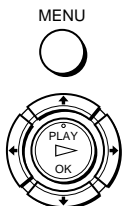

Press MENU, then press \uparrow/\downarrow to highlight SETTINGS and press OK.

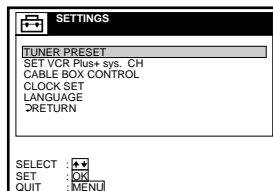

2



Press **↑/↓** to highlight TUNER PRESET, then press OK.

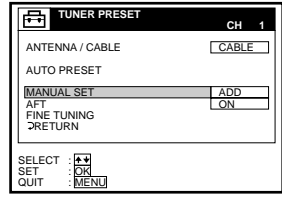

3

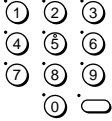

Press the number buttons to select the channel you want to fine-tune, then press ENTER.

Selected channel

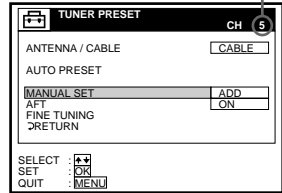

4



Press **↑/↓** to highlight FINE TUNING, then press OK.

The fine tuning meter appears.

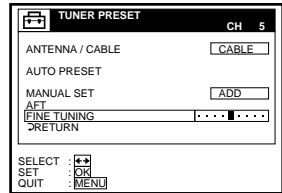

5



Press **←/→** to adjust to a clearer picture, then press OK.

Note that the AFT setting switches to OFF.

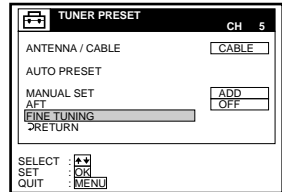

6

MENU



Press MENU to exit the menu.

Tips

- To select the channel in step 3 above, you can also use the CH +/- buttons. In this case, you don't need to press ENTER.
- If you want to return to the previous menu, highlight RETURN and press OK.

Note

- When adjusting FINE TUNING, the menu may become difficult to read due to interference from the picture being received.

Setting up the VCR Plus+® GOLD system (SLV-N81 only)

How the VCR Plus+ GOLD system works

Whenever you want to record a TV program, all you need to do is look up the “PlusCode” number, a number assigned to each program published in the TV section of most newspapers, cable TV listings, and even TV GUIDE magazine. Then, just enter the PlusCode number of the program you want and the VCR is automatically programmed to record that show. It’s that simple.

How to set up your VCR

Setting up your VCR involves coordinating the TV channel number (the number you turn to on your TV or VCR to watch a program) with the guide channel (the number that’s assigned to that channel in your program guide).

The VCR can set the guide channels automatically (see page 49), but you may have to set the guide channels manually depending on your area or the way you hooked up your VCR (see page 52).

To find the guide channel numbers, look at the “Channel Line-up Chart” in the program guide for your area that features VCR PlusCode numbers. It usually looks like the example to the right.

Example of “PlusCode”

		PlusCode
5:30	14 MOVIE — Musical (2hrs.)	33044
	2 SPORT — Golf (1hr. 25min.)	42060
	CNN — WS 9974	
6:30	2 3 4 DRAMA — Comedy (2hrs.)	17390
	5 SCIENCE AND TECHNOLOGY (1hr. 15min.)	73457

Example of “Channel Line-up Chart”

CABLE CH	CABLE TV	VCR Plus+ GUIDE CH
16	AMC American Movie Classics	35
17	BRV Bravo (program grid only)	54
20	CNN Cable News Network	42
21	CSP C-SPAN	28
22	DIS The Disney Channel	53
25	DSC The Discovery Channel	37
34	ESN ESPN	34
35	FAM The Family Channel	47
5	HBO Home Box Office	33
27	LIF Lifetime	46
29	MAX Cinemax	45
30	MTV Music Television	48
31	NIK Nickelodeon	38
38	SC Sports Channel	59
39	SCA Sports Channel America	70
45	SHO Showtime	41
17	TBS TBS SuperStation	43
44	TMC The Movie Channel	58
49	TNN The Nashville Network	49
50	TNT Turner Network Television	52
51	USA USA Network	44

Setting up the VCR Plus+ GOLD system automatically (Smart Channel Mapping)

The VCR can automatically set the guide channels in your area from ZIP/POSTAL CODE you entered in EASY SET UP. The VCR receives the program information signal and renews the data everyday after you complete the following procedure.

If you are having trouble setting the guide channels, or if you have many scrambled channels, go to page 52 for manual VCR Plus+ GOLD system set up. Note that the VCR Plus+ GOLD system does not work with a digital satellite receiver.

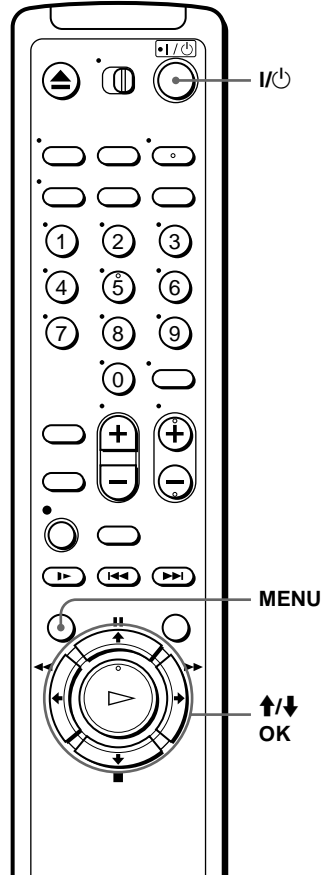

1

Set up the VCR using the EASY SET UP function.

2

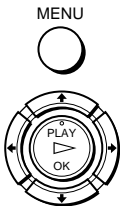

Press MENU, then press **↑/↓** to highlight SETTINGS and press OK.

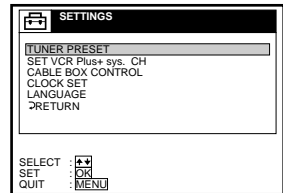

continued

3



Press **↑/↓** to highlight SET VCR Plus+ sys. CH, then press OK.

The SMART CHANNEL MAPPING menu appears.

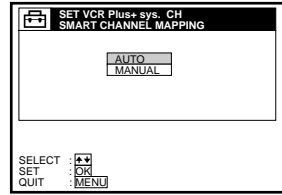

4



Press **↑/↓** to highlight AUTO, then press OK.

The instruction shown on the right appears on the TV screen for a few seconds, then the screen returns to the normal display.

- If you made Hookup 1: leave your cable box on for correct channel mapping.
- If you made Hookup 3: turn your cable box off for correct channel mapping.

Note that channel mapping does not work for Hookup 2 or 5.

If the program information signal in your area has several channel map patterns, the CHOOSE YOUR CABLE CH MAP menu appears, and you must select the channel map. See the following section “To select the channel map.”

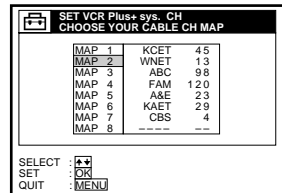

5



Press **I/O** to turn off the VCR.

The VCR sets the program guide channels from 0:00 am to 5:00 am while the VCR is turned off. (It takes about one hour to complete channel mapping.)

Tips

- After channel setup is finished, you can record TV programs using the VCR Plus+ GOLD system. For details, see page 70.
- If you want to return to the previous menu, highlight RETURN and press OK.

Note

- If the CHOOSE YOUR CABLE CH MAP menu appears the first time you turn on the VCR after finishing channel setup, see the following section “To select the channel map”.

To select the channel map

If the program information signal in your area has several channel map patterns (up to 8), the CHOOSE YOUR CABLE CH MAP menu appears:

- the first time you turn on the VCR after completing channel mapping
- after selecting AUTO and pressing OK on the SMART CHANNEL MAPPING menu

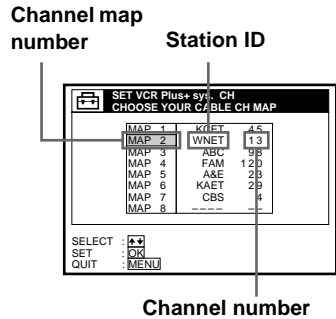

In this case, you have to select the channel map on the CHOOSE YOUR CABLE CH MAP menu.

- 1 Find the VCR Plus+ GOLD system Channel Listing in your program guide. For details, see page 48.
- 2 Press / to highlight the channel map number you want by checking the channel number in the program guide.
- 3 Press OK.

Notes

- It takes about one hour to complete channel mapping.
- The VCR can receive the program information signal only while the VCR is turned off and no timer recordings are set.
- The VCR cannot set the guide channels correctly unless you enter the ZIP/POSTAL CODE in your area.
- When you move to a different area, you must set up the VCR again and enter your new ZIP/POSTAL CODE in the EASY SET UP procedure.

continued

Setting up the VCR Plus+ GOLD system manually

To set the guide channels, use the Channel Line-up Chart to check that the guide channel numbers match the TV channel your VCR receives. For example, if HBO is listed in the Channel Line-up Chart as channel 33, and your VCR receives HBO on channel 5, you need to coordinate these numbers using the following procedure. If the guide and TV channel numbers are the same, you can skip this procedure.

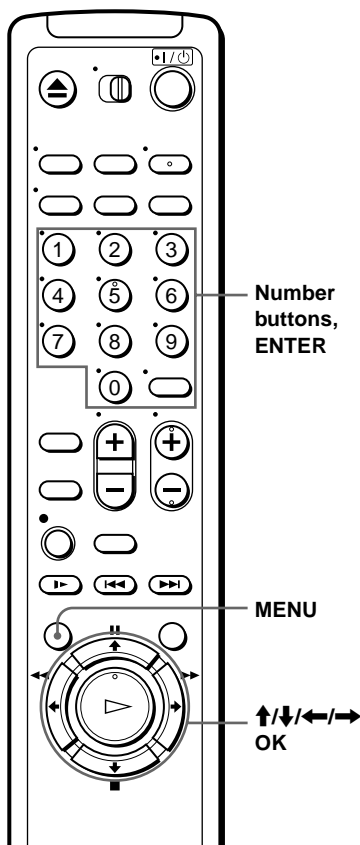

- 1** Press MENU, then press **↑/↓** to highlight SETTINGS and press OK.

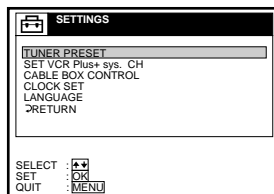
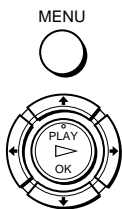

- 2** Press **↑/↓** to highlight SET VCR Plus+ sys. CH, then press OK.

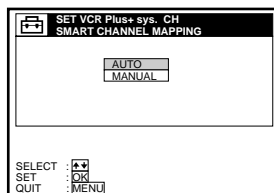

3



Press **↑/↓** to highlight **MANUAL**, then press **OK**.

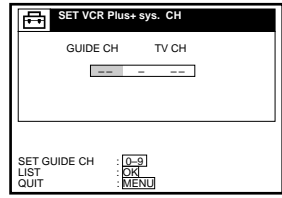

4

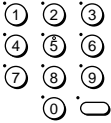

Enter the guide channel number assigned in the program guide and press **ENTER**.

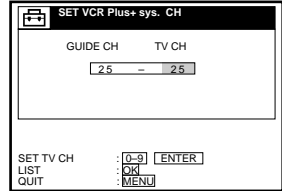

5

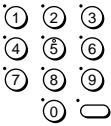

- If you made Hookup 1, 3, or 4: Enter the actual number on your TV (and VCR) and press **ENTER**.

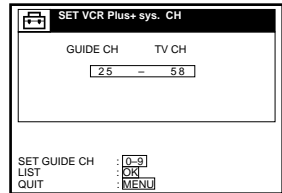

- If you made Hookup 5: Enter the cable box output channel (usually 2, 3, or 4) and press **ENTER**.

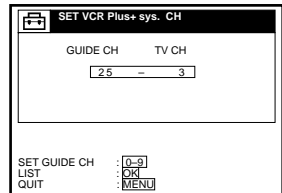

6

Repeat steps 4 and 5 for each channel number that does not match.

7



When you have set all channels, press **OK** to confirm your channel settings.

To return to the previous page, press **←**.

To go to the next page, press **→**.

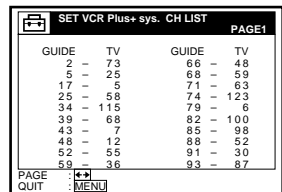

continued

8

MENU



After all settings are complete, press **MENU** to exit the menu.

Tip

- If you want to return to the previous menu, highlight **RETURN** and press **OK**.

Setting up the VCR Plus+® system (SLV-N71 only)

How the VCR Plus+ system works

Whenever you want to record a TV program, all you need to do is look up the “PlusCode” number, a number assigned to each program published in the TV section of most newspapers, cable TV listings, and even TV GUIDE magazine. Then, just enter the PlusCode number of the program you want and the VCR is automatically programmed to record that show. It’s that simple.

How to set up your VCR

Setting up your VCR involves coordinating the TV channel number (the number you turn to on your TV or VCR to watch a program) with the guide channel (the number that’s assigned to that channel in your program guide).

To find the guide channel numbers, look at the “Channel Line-up Chart” in the program guide for your area that features VCR PlusCode numbers. It usually looks like the example to the right.

To set the guide channels, use the Channel Line-up Chart to check that the guide channel numbers match the TV channel your VCR receives. For example, if HBO is listed in the Channel Line-up Chart as channel 33, and your VCR receives HBO on channel 5, you need to coordinate these numbers using the following procedure. If the guide and TV channel numbers are the same, you can skip this procedure.

Example of “PlusCode”

		PlusCode
5:30	14 MOVIE — Musical (2hrs.)	33044
	2 SPORT — Golf (1hr. 25min.)	42060
	CNN — WS 9974	
6:30	2 3 4 DRAMA — Comedy (2hrs.)	17390
	5 SCIENCE AND TECHNOLOGY (1hr. 15min.)	73457

Example of “Channel Line-up Chart”

CABLE CH	CABLE TV	VCR Plus+ GUIDE CH
16	AMC American Movie Classics	35
17	BRV Bravo (program grid only)	54
20	CNN Cable News Network	42
21	CSP C-SPAN	28
22	DIS The Disney Channel	53
25	DSC The Discovery Channel	37
34	ESN ESPN	34
35	FAM The Family Channel	47
5	HBO Home Box Office	33
27	LIF Lifetime	46
29	MAX Cinemax	45
30	MTV Music Television	48
31	NIK Nickelodeon	38
38	SC Sports Channel	59
39	SCA Sports Channel America	70
45	SHO Showtime	41
17	TBS TBS SuperStation	43
44	TMC The Movie Channel	58
49	TNN The Nashville Network	49
50	TNT Turner Network Television	52
51	USA USA Network	44

continued

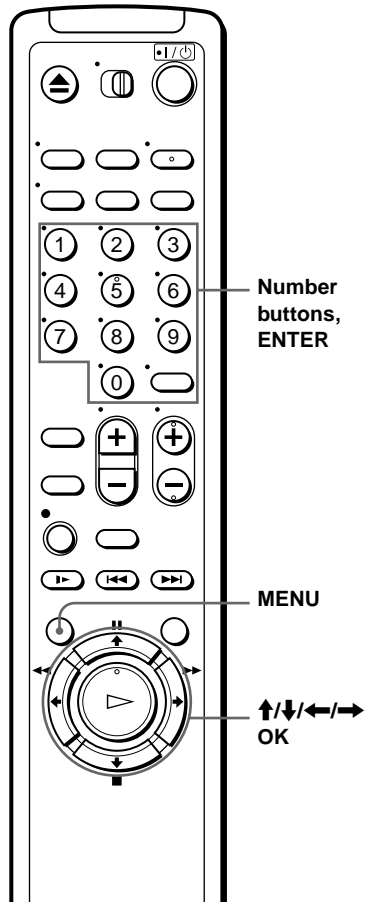

1

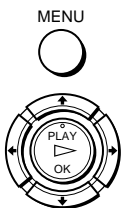

Press MENU, then press **↑/↓** to highlight SETTINGS and press OK.

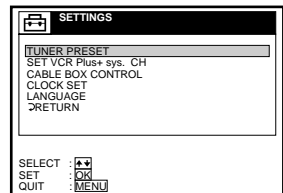

2



Press **↑/↓** to highlight SET VCR Plus+ sys. CH, then press OK.

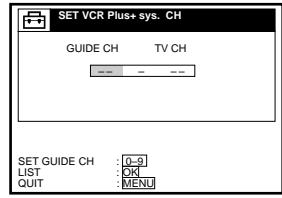

3

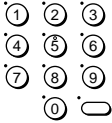

Enter the guide channel number assigned in the program guide and press ENTER.

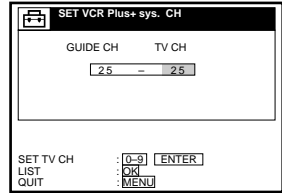

4

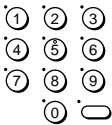

- If you made Hookup 3 or 4: Enter the actual number on your TV (and VCR) and press ENTER.

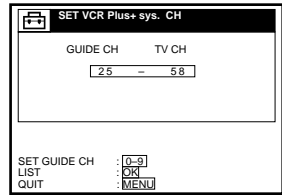

- If you made Hookup 5: Enter the cable box output channel (usually 2, 3, or 4) and press ENTER.

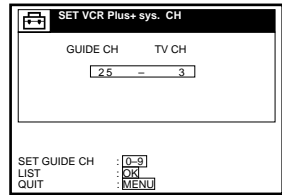

5

Repeat steps 3 and 4 for each channel number that does not match.

6



When you have set all channels, press OK to confirm your channel settings.

To return to the previous page, press **←**.

To go to the next page, press **→**.

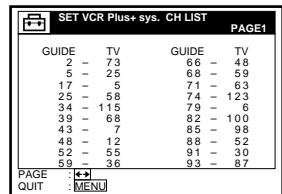

continued

7

MENU



After all settings are complete, press MENU to exit the menu.

Tip

- If you want to return to the previous menu, highlight RETURN and press OK.

Playing a tape

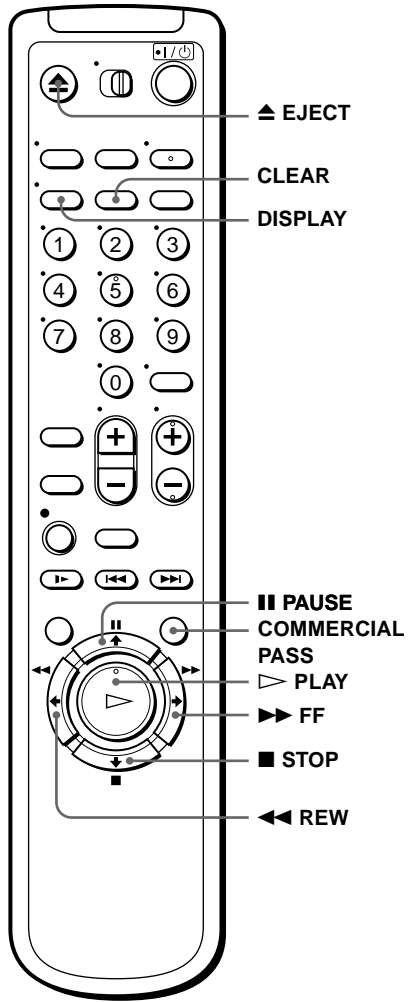

1

Turn on your TV and set it to the video channel.

continued

2

Insert a tape.

The VCR turns on and starts playing automatically if you insert a tape with its safety tab removed.

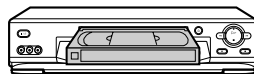
**3**

Press  PLAY.

When the tape reaches the end, it will rewind automatically.

Additional tasks

To	Press
Stop play	■ STOP
Pause play	PAUSE
Resume play after pause	PAUSE or ▷ PLAY
Fast-forward the tape	▶▶ FF during stop
Rewind the tape	◀◀ REW during stop
Eject the tape	▲ EJECT

To skip playback

By pressing a single button, you can skip a portion of playback you don't want to watch (such as a commercial) and restart playback.

- 1** Press COMMERCIAL PASS during playback of the scene you want to skip. The VCR starts searching.
- 2** Press COMMERCIAL PASS again when you find the scene you want to watch. The VCR stops searching, rewinds a few seconds, then resumes normal playback.

To use the time counter

Press CLEAR at the point on the tape that you want to find later. The counter in the display window resets to "0:00:00." Search for the point afterwards by referring to the counter.

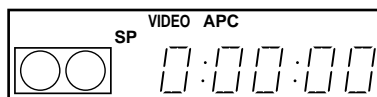

To display the counter on the TV screen, press DISPLAY.

Notes

- Tapes recorded in the LP mode on other VCRs can be played back on this VCR but the picture quality cannot be guaranteed.
- While displaying a menu on the TV screen, you cannot use ▷ PLAY, ■ PAUSE, ►► FF, ◀◀ REW, or ■ STOP buttons.
- The counter resets to “0:00:00” whenever a tape is reinserted.
- The counter stops counting when it comes to a portion with no recording.

Recording TV programs

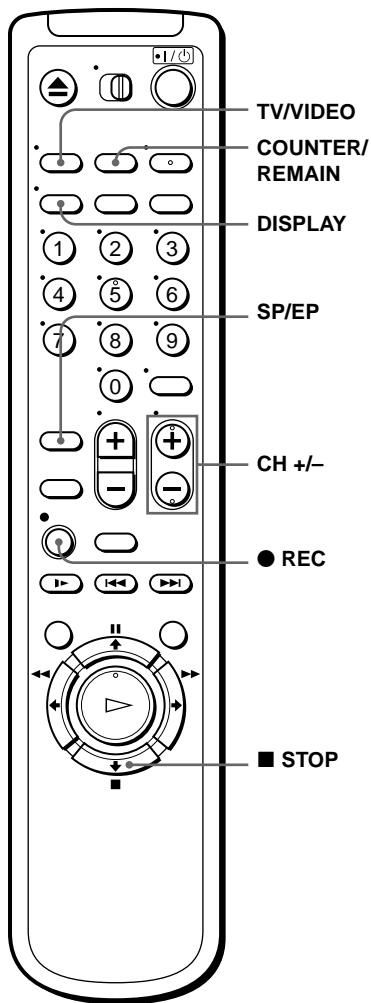

1 Turn on your TV and set it to the video channel.
To record from a cable box, turn it on.

2 Insert a tape with its safety tab in place.

3



Press CH +/- to select the channel or line input video source you want to record.



4



Press SP/EP to select the tape speed, SP or EP.

EP (Extended Play) provides recording time three times as long as SP (Standard Play). However, SP produces better picture and audio quality.



5



Press ● REC to start recording.

The recording indicator lights up red in the display window.

Recording indicator



To stop recording

Press ■ STOP.

To check the remaining tape length

Press DISPLAY repeatedly until the remaining tape length and the time counter appear on the TV screen. Each time you press COUNTER/REMAIN, the time counter and the remaining tape length with the ⌚ indicator appear alternately in the VCR's display window.

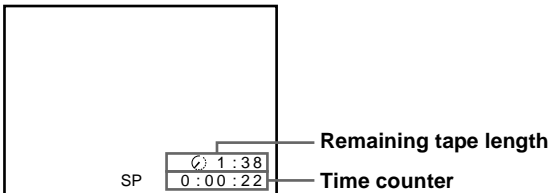

To check the remaining tape length of a T-140 or T-180 tape, set TAPE SELECT in the ADVANCED OPTIONS menu to 180. (For details, see page 92.)

continued

To watch another TV program while recording

- 1** Press TV/VIDEO to turn off the VIDEO indicator in the display window.
- 2** If the TV is connected to the VCR's LINE OUT jacks, set the TV to the TV's antenna input; if not, skip this step.
- 3** Select another channel on the TV.

To save a recording

To prevent accidental erasure, break off the safety tab as illustrated. To record on the tape again, cover the tab hole with adhesive tape.

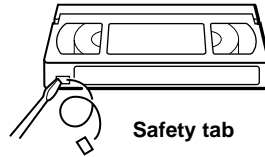

Tips

- To select a channel, you can use the number buttons on the remote commander. Enter the channel number, then press ENTER.
- You can select a video source from the LINE-1 IN or LINE-2 IN jacks using the INPUT SELECT button.
- The display appears on the TV screen indicating information about the tape, but the information won't be recorded on the tape.
- If you don't want to watch TV while recording, you can turn off the TV. When using a cable box, make sure to leave it on.

Notes

- The remaining tape length may not be indicated accurately for short tapes such as T-20 or T-30, or tapes recorded in the LP mode.
- The display does not appear during still (pause) mode or slow-motion playback.
- It may take up to one minute for the VCR to calculate and display the remaining tape length after you press DISPLAY.

Recording TV programs using the Dial Timer

The Dial Timer function allows you to make timer recordings of programs without turning on your TV. Set the recording timer to record up to eight programs that will be broadcast within a month using the DIAL TIMER. The recording start time and recording stop time can be set at one minute intervals.

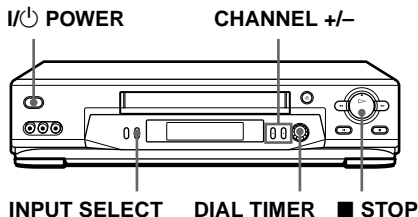

Before you start...

- When using a cable box, turn it on.
- Insert a tape with its safety tab in place. Make sure the tape is longer than the total recording time.

1 DIAL TIMER Press DIAL TIMER.



“DATE” and “TODAY” appear alternately in the display window.

If the date and time are not set, “MONTH” will appear. See step 2 in the following section “To set the clock” to set the date and time.

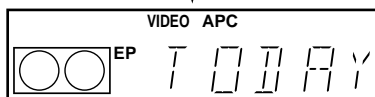

2 DIAL TIMER Turn DIAL TIMER to set the recording date.

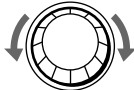

continued

3

DIAL TIMER



Press DIAL TIMER.

“START” and the current time appear alternately in the display window.

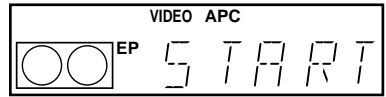

4

DIAL TIMER



Turn DIAL TIMER to set the recording start time.

You can set the recording start time in 15 minute intervals or adjust the time in one minute intervals by pressing the CHANNEL +/- buttons.

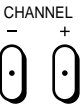

5

DIAL TIMER



Press DIAL TIMER.

“STOP” and the recording stop time appear alternately in the display window.

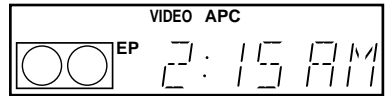

6

DIAL TIMER



Turn DIAL TIMER to set the recording stop time.

You can set the recording stop time in 15 minute intervals or adjust the time in one minute intervals by pressing the CHANNEL +/- buttons.

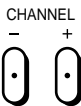

7

DIAL TIMER



Press DIAL TIMER.

The channel number or station ID (SLV-N81 only) appears in the display window.

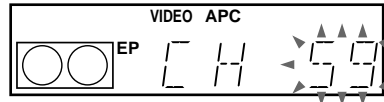

8

DIAL TIMER

INPUT
SELECT

Turn DIAL TIMER to set the channel number.

To record from a source connected to the LINE-1 IN or LINE-2 IN jacks, turn DIAL TIMER or press INPUT SELECT to display “L1” or “L2”.

If the CABLE BOX CONTROL setting is ON, you can change the channel number in units of 100 by pressing the CHANNEL +/- buttons (SLV-N81 only).

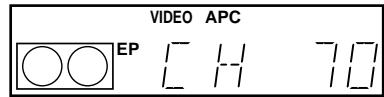

9

DIAL TIMER



Press DIAL TIMER to complete the setting.

“OK” appears in the display window for about five seconds.

The \odot indicator appears in the display window and the VCR stands by for recording. When using a cable box, leave it on.

To return to the previous step

To return to the previous step, press the CHANNEL + and – buttons on the VCR at the same time during any of the Dial Timer settings.

To stop recording

To stop the VCR while recording, press ■ STOP.

To use the VCR after setting the timer

To use the VCR before a timer recording begins, just press I/⏏. The \odot indicator disappears from the display window and the VCR switches on. Remember to press I/⏏ to reset the VCR to the timer recording standby mode after using the VCR.

You can also do the following tasks while the VCR is recording:

- Reset the counter (page 60).
- Display tape information on the TV screen (page 63).
- Check the timer settings (page 80).
- Watch another TV program (page 64).

continued

To set the clock

- 1 Turn DIAL TIMER so that “CLOCK” appears in the display window.
- 2 Press DIAL TIMER.
“MONTH” appears in the display window.
- 3 Turn DIAL TIMER to set the month.
- 4 Press DIAL TIMER.
“DAY” appears in the display window.
- 5 Turn and press DIAL TIMER to set the day and then the year.
After you set the year, “CLOCK” appears in the display window again.
- 6 Turn and press DIAL TIMER to set the hour and minute.
- 7 When you have finished setting the time, press DIAL TIMER to start the clock.

Tips

- To cancel a Dial Timer setting, press ■ STOP on the VCR while you are making the setting.
- The program is recorded in the current tape speed. To change the tape speed, press SP/EP before you complete the setting in step 9 (page 67).
- When you are recording a program in the SP mode and the remaining tape becomes shorter than the recording time, the tape speed is automatically changed to the EP mode. Note that some noise will appear on the picture when the tape speed is changed. If you want to keep the tape speed, set AUTO TAPE SPEED to OFF in the ADVANCED OPTIONS menu (page 92).
- To check, change, or cancel the program setting, see “Checking/changing/canceling timer settings” (page 80).

Notes

- If eight programs have already been set using the VIDEO Plus+/VIDEO Plus+ GOLD system or the TIMER SET/CHECK menu, “FULL” appears in the display window for about five seconds.
- If you are using the Cable Mouse, you cannot select “L1” or “L2.”(SLV-N81 only)
- If you set the clock using the Auto Clock Set function, the clock will adjust itself to the incoming time signal regardless of adjustments made with the Dial Timer. Be sure you have set ACS correctly.
- If you are setting the clock for the first time or “-:-” appears in the display window, you cannot set the clock to February 29th using the Dial Timer. Please use the Auto Clock Set function to set the VCR to this day.
- The Ⓢ indicator flashes in the display window when you complete the setting in step 9 (page 67) with no tape inserted.
- The station ID appears on the TV screen only when you complete Smart Channel Mapping and the VCR receives the program information signal (SLV-N81 only) (see page 49).

About the Demonstration Mode

The Dial Timer function has a Demonstration Mode that allows the user, such as a salesperson, to enter more than eight examples of timer settings when demonstrating the use of the Dial Timer. It cancels the FULL notice which appears if eight programs have already been set. Do not use the Demonstration Mode for making timer recordings. Doing so may cause the settings to be inaccurate.

To activate the Demonstration Mode

Press **|| PAUSE** on the VCR while turning the DIAL TIMER. “DEMO” appears in the display window for a few seconds.

To cancel the Demonstration Mode

Turn the power off and unplug the AC power cord. Although the Demonstration Mode is canceled, the timer settings entered while using the Demonstration Mode will remain. Be sure to manually cancel the timer settings before you use the Dial Timer or any other timer method after reconnecting the AC power cord (see page 80).

Recording TV programs using the VCR Plus+ or VCR Plus+ GOLD system

Just enter the PlusCode number listed in the TV program guide. The date, time and channel number of that program are set automatically. You can preset up to eight programs together with the DIAL TIMER and manual timer settings at one time.

Before you start...

- Check that the VCR clock is set to the correct time.
- Turn on your TV and set it to the video channel. When using a cable box, turn it on.
- Insert a tape with its safety tab in place. Make sure the tape is longer than the total recording time.

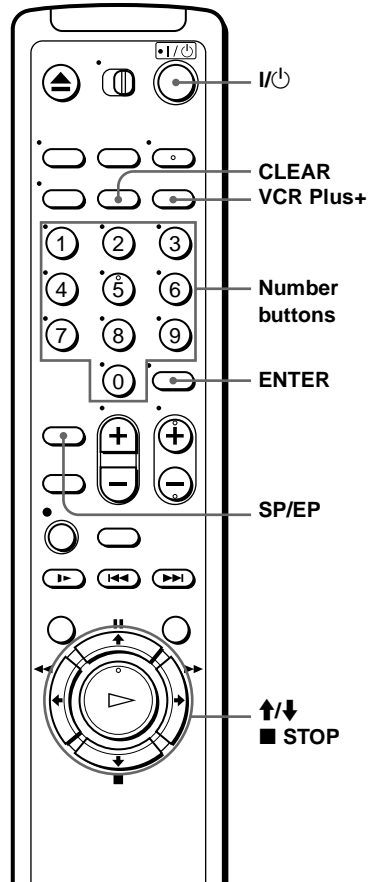

1 VCR Plus+ Press VCR Plus+.

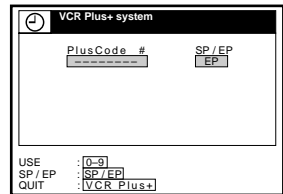

2

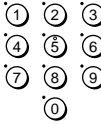

Press the number buttons to enter the PlusCode number.

If you make a mistake, press CLEAR and re-enter the correct number.

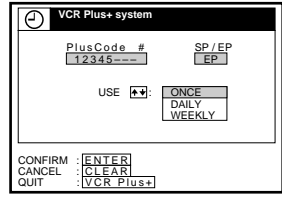

3



Press SP/EP to select the tape speed, SP or EP.

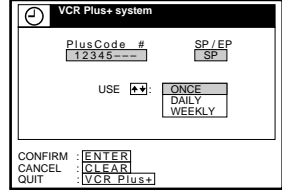

4



Press **↑/↓** to highlight ONCE, DAILY, or WEEKLY, then press ENTER:



To record	Select
Only once	ONCE
Everyday Monday to Friday	DAILY
Once a week	WEEKLY



The date, start and stop time, channel number (or station ID for SLV-N81 only), and tape speed appear on the TV screen. If the information is not correct, press CLEAR to cancel the setting.

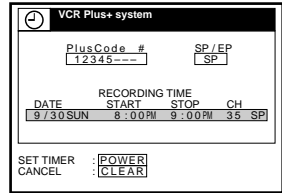

5

To enter another setting, repeat steps 1 to 4.

6



Press **I/⏻** to turn off the VCR.



The **⏻** indicator appears in the display window and the VCR stands by for recording. When using a cable box, leave it on.

To stop recording

To stop the VCR while recording, press **■ STOP**.

continued

To use the VCR after setting the timer

To use the VCR before timer recording begins, just press I/⏻. The ⏻ indicator disappears from the display window and the VCR switches on. Remember to press I/⏻ to reset the VCR to the timer recording standby mode after using the VCR.

You can also do the following tasks while the VCR is recording:

- Reset the counter (page 60).
- Display tape information on the TV screen (page 63).
- Check the timer settings (page 80).
- Watch another TV program (page 64).

Tips

- To check, change or cancel the program setting, see “Checking/changing/canceling timer settings” (page 80).
- When you are recording a program in the SP mode and the remaining tape becomes shorter than the recording time, the tape speed is automatically changed to the EP mode. Note that some noise will appear on the picture when the tape speed is changed. If you want to keep the tape speed, set AUTO TAPE SPEED to OFF in the ADVANCED OPTIONS menu (page 92).

Notes

- If the VCR does not accept the PlusCode number, this means that:
 - The PlusCode number is incorrect.
 - ONCE, DAILY, or WEEKLY was selected incorrectly. You cannot select DAILY or WEEKLY for a program that airs more than seven days ahead.
- The station ID appears on the TV screen only when you complete Smart Channel Mapping and the VCR receives the program information signal (SLV-N81 only) (see page 49).

Setting the timer manually

If the VCR Plus+ or VCR Plus+ GOLD system is not available in your area, follow the instructions below to set the timer to record programs.

Before you start...

- Check that the VCR clock is set to the correct time.
- Turn on your TV and set it to the video channel. When using a cable box, turn it on.
- Insert a tape with its safety tab in place. Make sure the tape is longer than the total recording time.

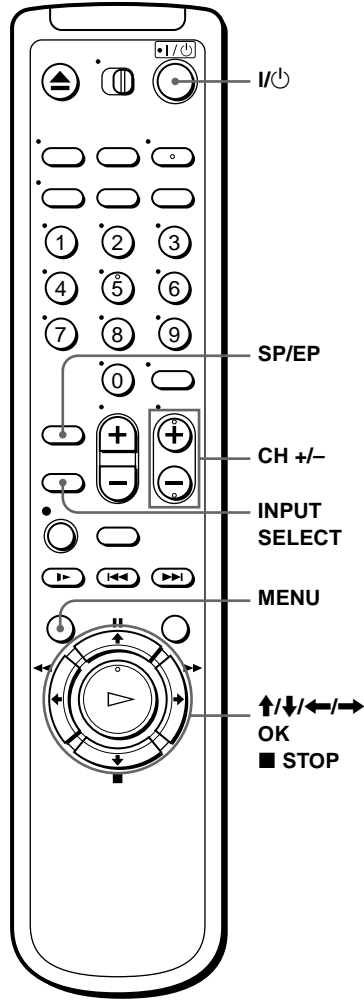

1

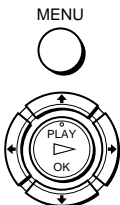

Press MENU, then press **↑/↓** to highlight **TIMER SET/CHECK** and press OK.

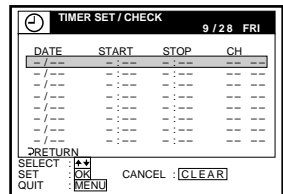

continued

2



Press **↑/↓** to highlight the line that is to be set, then press **OK**.

3



Set the date, start and stop time, channel number, and tape speed:

1 Press **↑/↓** to set each item.

2 Press **→** to highlight and set each item in turn.

INPUT
SELECT



• CH



To correct a setting, press **←** to return to that setting and reset.

When you set the channel number, the station ID may appear in the “CH” position. You can set it while checking the station ID (SLV-N81 only).

To record the same program every day or the same day every week, press **↓** while the date is highlighted. For details, see “Daily/weekly recording” on page 75.

To record from a source connected to the LINE-1 IN or LINE-2 IN jacks, press **INPUT SELECT** or **CH +/-** to display “L1” or “L2” in the “CH” position.

TIMER SET / CHECK				
9 / 28 FRI				
DATE	START	STOP	CH	
9 / 30 SUN	9 : 00 PM	9 : 00 PM	35 SP	
- / - -	- : - -	- : - -	- - - -	
- / - -	- : - -	- : - -	- - - -	
- / - -	- : - -	- : - -	- - - -	
- / - -	- : - -	- : - -	- - - -	
- / - -	- : - -	- : - -	- - - -	
RETURN				
SELECT :	← →		END : OK	
SET :	← →			
QUIT :	MENU			

4



Press **OK** to confirm the setting.

To enter another setting, press **↑/↓** to highlight the next line and repeat step 3.

5

MENU



Press **MENU** to exit the menu.

6



Press **I/⏮** to turn off the VCR.



The **⏮** indicator appears in the display window and the VCR stands by for recording.

When using a cable box, leave it on.

To stop recording

To stop the VCR while recording, press **■ STOP**.

Daily/weekly recording

In step 3 on page 74, press **↓** to select the recording pattern. Each time you press **↓**, the indication changes as shown below. Press **↑** to change the indication in reverse order.

the current date → **SUN-SAT** → **MON-SAT** → **MON-FRI** → **EVERY SAT** → → **EVERY MON** → **EVERY SUN** → **1 month later** → **(dates count down)** → **the current date**

To use the VCR after setting the timer

To use the VCR before timer recording begins, just press **I/⏻**. The **⏻** indicator disappears from the display window and the VCR switches on. Remember to press **I/⏻** to reset the VCR to the timer recording standby mode after using the VCR.

You can also do the following tasks while the VCR is recording:

- Reset the counter (page 60).
- Display tape information on the TV screen (page 63).
- Check the timer settings (page 80).
- Watch another TV program (page 64).

Tips

- To set the channel, you can also use the CH+/- or number buttons.
- To set the tape speed, you can also use the SP/EP button.
- When you are recording a program in the SP mode and the remaining tape becomes shorter than the recording time, the tape speed is automatically changed to the EP mode. Note that some noise will appear on the picture when the tape speed is changed. If you want to keep the tape speed, set AUTO TAPE SPEED to OFF in the ADVANCED OPTIONS menu (page 92).
- To check, change or cancel the program setting, see “Checking/changing/canceling timer settings” (page 80).
- If you want to return to the previous menu and continue with other operations after setting the timer, press **↓** to highlight RETURN, then press OK.
The display returns to the MENU screen.
If you are finished using the VCR, turn off the power before timer recording starts.

Notes

- If you are using a Cable Mouse, you cannot select “L1” or “L2.” (SLV-N81 only)
- The station ID appears on the TV screen only when you complete Smart Channel Mapping and the VCR receives the program information signal (SLV-N81 only) (see page 49).

Locking the VCR (Child Lock)

After you have set the timer, you can lock all of the buttons on the VCR so that the settings are not canceled by mistake.

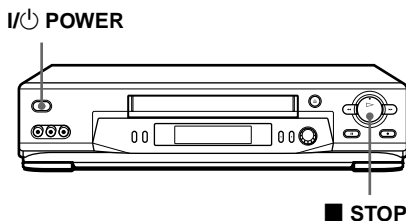

To lock the VCR

When the VCR is turned on, hold down **I/⏻ POWER** on the VCR until the **⏻** indicator appears in the display window. The VCR turns off and the **⏻** indicator remains lit. The VCR will not work except for timer recordings.

To unlock the VCR

Hold down **I/⏻ POWER** on the VCR until the **⏻** indicator disappears from the display window. The VCR is unlocked and turns on.

To stop timer recording while the VCR is locked, press **■ STOP**. The recording stops and the VCR is unlocked.

Note

- The VCR will be unlocked when:
 - You stop timer recording by pressing **■ STOP**.
 - You insert a tape.
 - The AC power cord is disconnected or power supply stops.

Playing/searching at various speeds

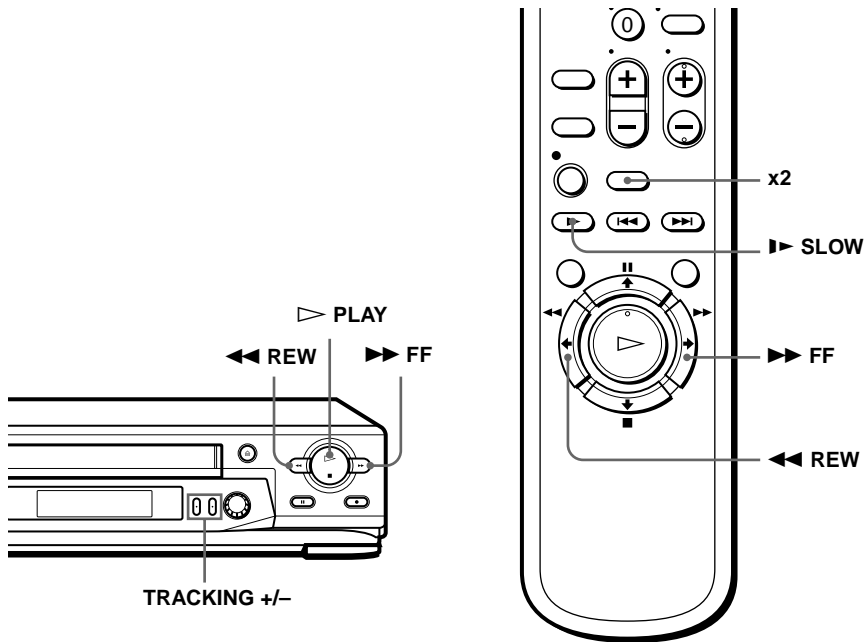

Additional Operations

Playback options	Operation
View the picture during fast-forward or rewind	During fast-forward, hold down ►► FF. During rewind, hold down ◄◄ REW.
Play at high speed	<ul style="list-style-type: none"> • During playback, briefly press ►► FF or ◄◄ REW <u>on the remote commander</u>. The tape continues to play at high speed. • During playback, hold down ►► FF or ◄◄ REW. When you release the button, normal playback resumes.
Play at twice the normal speed	During playback, press ×2.
Play in slow motion	During playback or pause, press ► SLOW.
Play frame by frame	During pause, press ►► FF or ◄◄ REW <u>on the remote commander</u> . Hold down the button to play one frame each second.
Rewind and start play	While the tape is stopped, hold down ◄◄ REW <u>on the VCR</u> and press ▷ PLAY <u>on the VCR</u> .

To resume normal playback

Press ▷ PLAY.

continued

Tip

- Adjust the picture using the TRACKING +/- buttons if:
 - Streaks appear while playing in slow motion.
 - The picture shakes during pause.To set tracking to the center position, press both buttons (+/-) at the same time.

Notes

- The sound is muted during these operations.
- Tapes recorded in the LP mode on other VCRs can be played back on this VCR but the picture quality cannot be guaranteed.
- The picture may show noise when playing at high speed in reverse.

Setting the recording duration time

After you have started recording, you can have the VCR stop recording automatically after a specified duration.

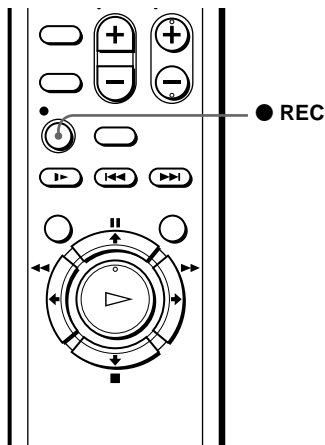

- 1 While recording, press ● REC.
The ⏸ indicator appears in the display window.

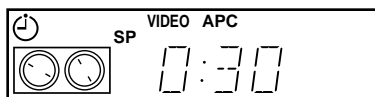

- 2 Press ● REC repeatedly to set the duration time.
Each press advances the time in increments of 30 minutes.

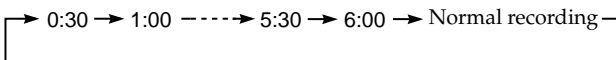

The tape counter decreases minute by minute to 0:00, then the VCR stops recording and turns off automatically.

To extend the duration

Press ● REC repeatedly to set a new duration time.

To cancel the duration

Press ● REC repeatedly until the ⏸ indicator disappears and the VCR returns to normal recording mode.

To stop while recording

Press ■ STOP.

Note

- You cannot display the current tape time in the display window when setting the recording duration time.

Checking/changing/canceling timer settings

Before you start...

- Turn on your TV and set it to the video channel.

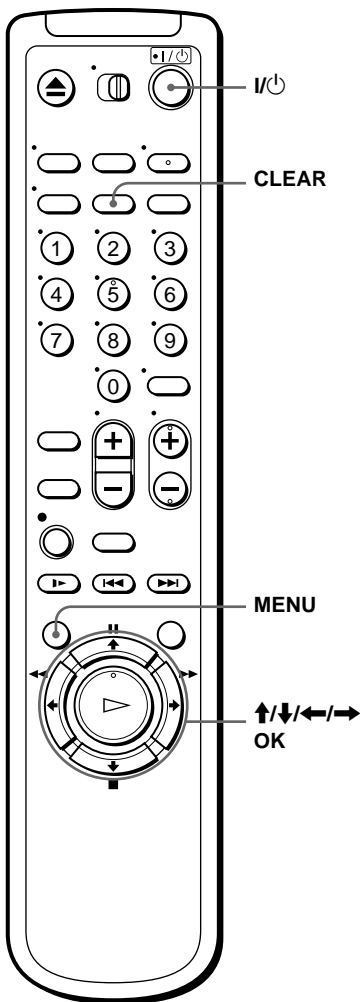

- 1** Press I/Power to turn on the VCR.
- 2** Press MENU, then press \uparrow/\downarrow to highlight TIMER SET/CHECK and press OK.
 - If you want to change a setting, go on to the next step.
 - If you do not need to change the settings, press MENU, then turn off the VCR to return to recording standby.

3 Press **↑/↓** to highlight the setting you want to change or cancel.

- To change the setting, press **OK** and press **←/→** to highlight the item you want to change, then press **↑/↓** to reset it.
- To cancel the setting, press **CLEAR**.

TIMER SET / CHECK				9 / 28 FRI	
DATE	START	STOP	CH		
9 / 30 SUN	8 : 00 PM	9 : 00 PM	35	SP	
10 / 2 TUE	10 : 00 AM	11 : 30 AM	20	EP	
MON - FRI	2 : 00 PM	3 : 00 PM	60	EP	
EVERY SUN	6 : 30 AM	7 : 00 AM	42	EP	
- / - -	- : - -	- : - -	- -	- -	- -
- / - -	- : - -	- : - -	- -	- -	- -
- / - -	- : - -	- : - -	- -	- -	- -
- / - -	- : - -	- : - -	- -	- -	- -
▶ RETURN					
SELECT	↑/↓				
SET	OK			CANCEL :	[CLEAR]
QUIT	←/→				[MENU]

4 Press **OK**.

5 Press **MENU** to exit the menu.

If any timer settings remain, turn off the VCR to return to recording standby.

When the timer settings overlap

The program that starts first has priority and the second program starts recording only after the first program has finished. If the programs start at the same time, the program listed first in the menu has priority.

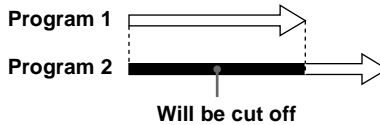

Recording stereo and bilingual programs

Recording stereo programs

This VCR automatically receives and records stereo programs. When a stereo program is received, the STEREO indicator lights up. If there is noise in the stereo program, set AUTO STEREO in the ADVANCED OPTIONS menu to OFF. The sound will be recorded in monaural (on both hi-fi and normal audio tracks) but with less noise. For details, see page 92.

Recording bilingual programs

Normally, this VCR records only the main sound. When a SAP (Second Audio Program) is received, the SAP indicator lights up. To record only SAP sound, set TUNER AUDIO in the ADVANCED OPTIONS menu to SAP. For details, see page 92.

Selecting the sound during playback

Press AUDIO MONITOR to select the sound you want.

To listen to	On-screen display	Display window
Stereo	STEREO	STEREO
Left channel	L	STEREO
Right channel	R	STEREO
Monaural sound on the normal audio track	No indicator	No indicator

How sound is recorded on a video tape

The VCR records sound onto two separate tracks. Hi-fi audio is recorded onto the main track along with the picture. Monaural sound is recorded onto the normal audio track along the edge of the tape.

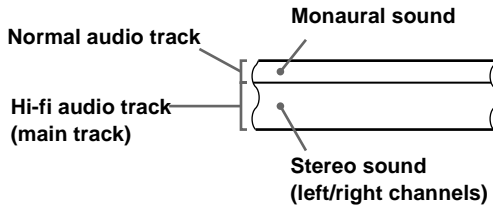

Notes

- To play a tape in stereo, you must use the A/V connections.
- When you play a tape recorded in monaural, the sound is heard in monaural regardless of the AUDIO MONITOR setting.

Searching using the index function

The VCR automatically marks the tape with an index signal at the point where each recording begins. Use these signals as references to find a specific recording.

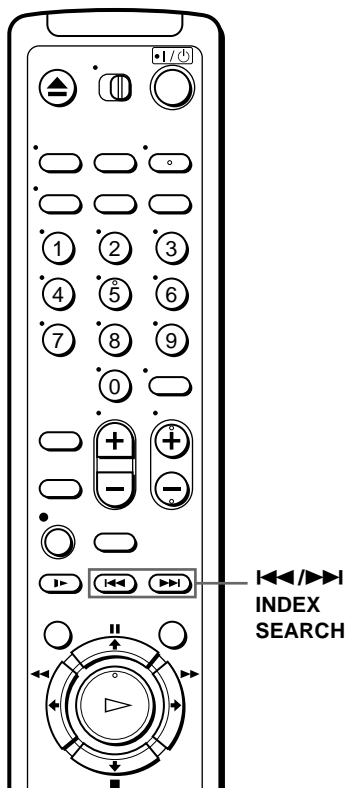

- 1 Insert an indexed tape into the VCR.
- 2 Press **◀◀/▶▶** INDEX SEARCH.
 - To search ahead, press **▶▶** INDEX SEARCH.
 - To search backwards, press **◀◀** INDEX SEARCH.

The VCR starts searching, and playback starts automatically from that point.

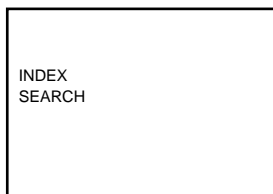

To stop searching

Press **■** STOP.

Note

- No index signal will be added when recording starts from recording pause. However, an index signal will be marked if you change the channel during recording pause.

Searching for a selected point on the tape

You can easily find a specific point by moving the pointer on the TV screen.

The VCR fast-forwards or rewinds to the point you indicate and starts playback automatically.

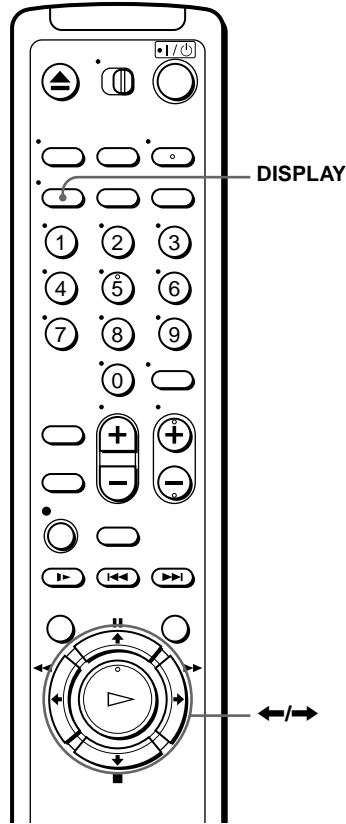

- 1 Press DISPLAY repeatedly until the bar indication appears on the TV screen.

A cursor (■) indicating the current position of the tape appears on the bar indication. If the cursor does not appear, play the tape a few moments (by pressing ▷ PLAY, ▷▷ FF, or ◀◀ REW) until the cursor appears.

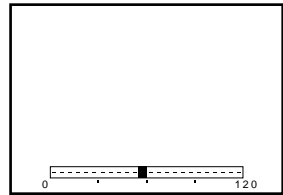

- 2 Press ◀/▶ to move the pointer (▼) to the point where you want to start playback.

The VCR starts searching and the cursor (■) moves toward the pointer. When the VCR locates the marked point, playback starts.

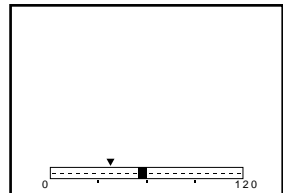

continued

To cancel searching

Press ▷ PLAY or ■ STOP.

To turn off the bar indication

Press DISPLAY again.

Notes

- The figure on the bar indication represents the total time length of the inserted tape as shown below.
The total time length may not be displayed correctly for:
 - Tapes other than T-60, T-120, or T-160.
 - Tapes recorded in more than one tape speed mode.

Tape type	Total time length		
	SP	LP	EP
T-60 or shorter	60	120	180
from T-80 to T-140	120	240	360
T-160 or longer	160	320	480

- If you move the pointer (▼) on the bar indication while searching, the VCR searches for the new reset point.
- With the bar indication on, the ►► FF/ ➡ and ◀◀ REW/ ◀ buttons on the remote commander work only for moving the pointer (▼) and are not used for normal tape operation. The ►► FF and ◀◀ REW buttons on the VCR are used for normal tape operation. Note, however, if you press these buttons on the VCR, searching is canceled.

Locating a channel by Station ID (SLV-N81 only)

You can select a TV program using the station's ID.

Before you start...

- Set FAVORITE CH to OFF in the ADVANCED OPTIONS menu (page 93).
- If a cable box is connected to your VCR, turn it on.

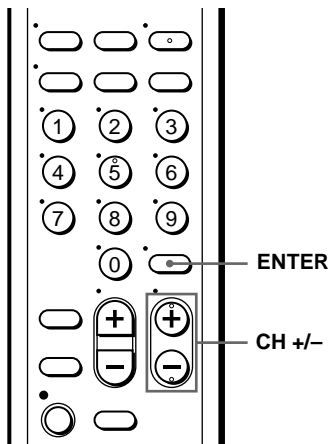

1 Turn on your TV and set it to the video channel.

2 Press ENTER.
The station ID appears on the TV screen.

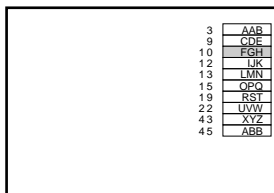

3 Press CH +/- to select the station ID you want.

The selected station ID

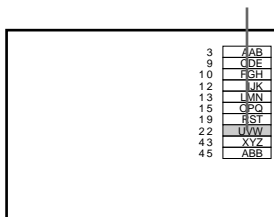

4 Press ENTER.

Note

- If the TV channel has no station ID, the channel number appears on the TV screen.

Creating a favorite channel list with Station ID (SLV-N81 only)

You can create your favorite channel list of TV channels with Station ID. You can store up to 10 channels with Station ID and select the channel from your favorite channel list.

Before you start...

- Set FAVORITE CH to ON in the ADVANCED OPTIONS menu (page 93).
- If a cable box is connected to your VCR, turn it on.

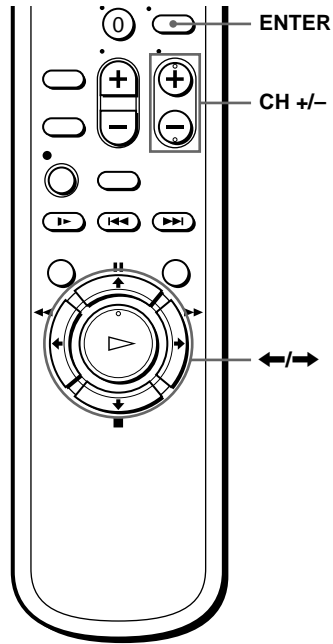

Creating your favorite channel list

- 1** Press ENTER.
The FAVORITE CH screen appears on the TV screen.
- 2** Press CH +/- to select the station ID you want to replace.

The selected station ID

FAVORITE CH	
12	ABE
15	CDE
9	FGH
13	JK
19	LNM
3	OPQ
45	RST
43	UVW
22	XYZ
10	ABB

- 3** Press **←/→** to select the station ID you want to set.

FAVORITE CH	
12	AAB
15	CDE
27	FGH
13	IJK
19	LMN
3	OPQ
46	RST
43	UVW
22	XYZ
10	ABB

- 4** Repeat steps 2 and 3 to set the station IDs as needed.
- 5** Press **ENTER**.

Selecting a channel from your favorite channel list

- 1** Turn on your TV and set it to the video channel.
To choose a channel from a cable box, turn the cable box on.

- 2** Press **ENTER**.
Your **FAVORITE CH** screen appears on the TV screen.

FAVORITE CH	
12	AAB
15	CDE
27	FGH
13	IJK
19	LMN
3	OPQ
46	RST
43	UVW
22	XYZ
10	ABB

- 3** Press **CH +/-** to select the station ID you want to select.

The selected station ID

FAVORITE CH	
12	AAB
15	CDE
27	FGH
13	IJK
19	LMN
3	OPQ
46	RST
43	UVW
22	XYZ
10	ABB

- 4** Press **ENTER**.

Note

- If the TV channel has no station ID, the channel number appears on the TV screen.

Adjusting the picture

Adjusting the tracking

Although the VCR automatically adjusts the tracking when playing a tape (the  indicator flashes in the display window, then turns off), distortion may occur if the recording is in poor condition. In this case, manually adjust the tracking.

Press TRACKING +/- to display the tracking meter. The distortion should disappear as you press one of the two tracking buttons (the  indicator lights up). To resume automatic tracking adjustment, eject the tape and reinsert it.

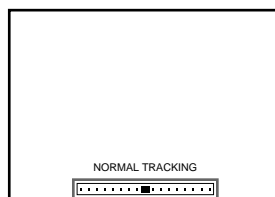



Tracking meter

About the Reality Regenerator function (SLV-N81 only)

The Reality Regenerator function automatically restores the picture to its original quality during playback.

To use the Reality Regenerator function

- 1 Press MENU, then select ADVANCED OPTIONS and press OK.
- 2 Press  to highlight NEXT, then press OK.
- 3 Press  to highlight REALITY REGENERATOR on PAGE2 of the ADVANCED OPTIONS menu, then press OK.

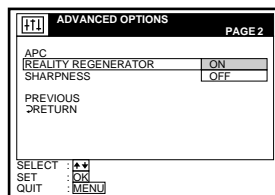

- 4 Press  to set REALITY REGENERATOR to ON, then press OK. The RR indicator lights up in the display window.
- 5 Press MENU to return to the original screen.

To turn it off, select OFF in step 4. The RR indicator turns off in the display window.

About the Adaptive Picture Control (APC) function

The Adaptive Picture Control (APC) function automatically improves recording and playback quality by adjusting the VCR to the condition of the video heads and tape. To maintain better picture quality, we recommend that you set APC to ON on PAGE2 of the ADVANCED OPTIONS menu (The APC indicator lights up in the display window). For details, see page 93.

APC playback

The APC function automatically works on all types of tapes, including rental tapes and tapes that were not recorded with APC.

APC recording

Whenever you insert a tape and first start recording, the VCR adjusts to the tape using the APC function (the APC indicator flashes rapidly). This adjustment is retained until the tape is ejected.

Notes

- The auto tracking adjustment cannot be guaranteed to work with tapes recorded in the LP mode on other VCRs.
- The APC function does not work if the tape speed is automatically changed from the SP to EP mode during a timer recording when AUTO TAPE SPEED is set to ON in the ADVANCED OPTIONS menu, unless the tape has been recorded in the EP mode with the APC function.
- There is a delay of about ten seconds before the VCR actually starts recording while the VCR analyzes the tape. To avoid the delay, first set the VCR to recording pause (the APC indicator flashes slowly) and press ● REC to have the VCR analyze the tape (the APC indicator flashes rapidly) and return to recording pause. After the APC indicator stops flashing, press ■■ PAUSE to start recording immediately.

If you want to start recording quickly without using the APC function, first set the VCR to recording pause (the APC indicator flashes slowly) and press ■■ PAUSE again to start recording.

Changing menu options

- 1 Press MENU, then select ADVANCED OPTIONS and press OK.

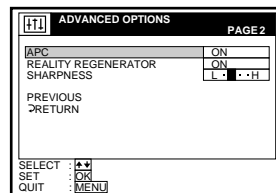
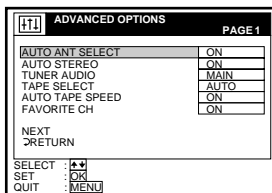

- 2 Press **↑/↓** to highlight the option to change, then press OK.
To go to PAGE2, highlight NEXT and press OK. To return to PAGE1, highlight PREVIOUS and press OK.
- 3 Press **↑/↓** to change the setting, then press OK.
To adjust the sharpness, press **←/→** and press OK.
- 4 Press MENU to return to the original screen.

Menu choices

Initial settings are indicated in bold print.

PAGE 1

Menu option	Set this option to
AUTO ANT SELECT	<ul style="list-style-type: none"> • ON if your TV is connected only to VHF/UHF OUT on the VCR. To play a tape, set the TV to the VCR channel (channel 3 or 4). • OFF if your TV is connected to both VHF/UHF OUT and LINE OUT on the VCR. To play a tape, set the TV to the VCR input.
AUTO STEREO	<ul style="list-style-type: none"> • ON to receive stereo programs. • OFF to reduce noise. The sound changes to monaural.
TUNER AUDIO	<ul style="list-style-type: none"> • MAIN to record the main sound on both hi-fi and normal audio tracks. • SAP to record the SAP (Second Audio Program) sound on both hi-fi and normal audio tracks.
TAPE SELECT	<ul style="list-style-type: none"> • AUTO when using a T-160 length tape or any tape shorter than a T-140 length tape. • 180 when using a T-140 or T-180 length tape. <p>For details, see page 63.</p>
AUTO TAPE SPEED	<ul style="list-style-type: none"> • ON to change the timer recording tape speed automatically to the EP mode when the remaining tape length becomes shorter than the recording time. To operate AUTO TAPE SPEED, set TAPE SELECT correctly. • OFF to keep the same tape speed.

Menu option	Set this option to
FAVORITE CH (SLV-N81 only)	<ul style="list-style-type: none"> • ON when using favorite channel list. • OFF when using station ID list. For details, see pages 87 and 88.

PAGE 2

Menu option	Set this option to
APC	<ul style="list-style-type: none"> • ON to switch on the APC (Adaptive Picture Control) function and improve picture quality. • OFF to switch off APC.
REALITY REGENERATOR (SLV-N81 only)	<ul style="list-style-type: none"> • ON to switch on the Reality Regenerator function and restore the picture to its original quality during playback. • OFF to switch off Reality Regenerator.
SHARPNESS	<ul style="list-style-type: none"> • L (Low) through H (High) to adjust the sharpness of the picture. Select L to turn off the sharpness control.

Editing with another VCR

How to connect to record on this VCR

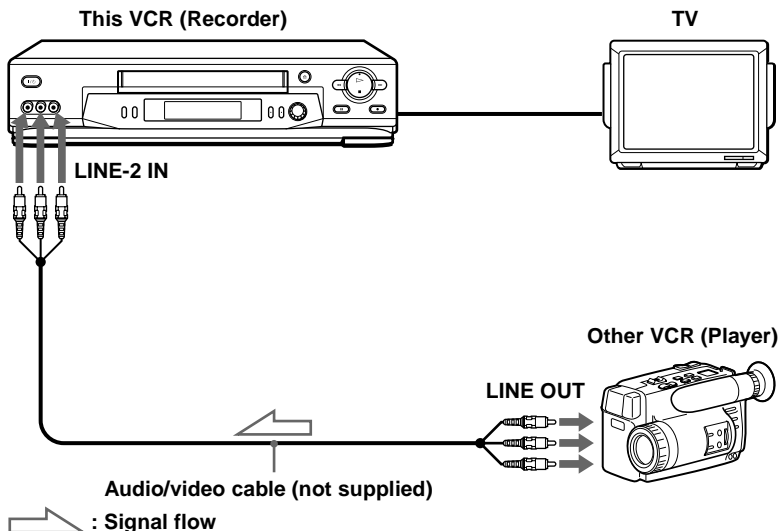

Notes

- Make sure you connect the plugs to jacks of the same color.
- If the other VCR is a monaural type and connected to this VCR's LINE-2 IN jacks, connect the audio plug to the AUDIO L (white) jack. The sound is recorded on both right and left channels. If you connect to the AUDIO R (red) jack, the sound is recorded only on the right channel.
- If you connected this VCR to both the LINE IN and LINE OUT jacks of the other VCR, select the input correctly to prevent a humming noise.
- You can use the LINE-1 IN jacks for editing. If the other VCR is a monaural type, the sound is recorded only on the channel whose jack is connected to the audio plug. To record on both right and left channels, connect the audio plugs to the AUDIO R/L jacks using a VMC-910HG audio/video cable (not supplied).

How to record on another VCR that has a CONTROL S OUT jack for synchronized editing (SLV-N81 only)

Connect to record on the other VCR using the audio/video cable, then connect the VCRs via the CONTROL S jacks using a Control S cable. The CONTROL S connection lets you control (pause and release pause) both VCRs from the other VCR. Connect the CONTROL S OUT jack of the other VCR to the CONTROL S IN jack on this VCR.

Note

- (SLV-N81 only)
If the CONTROL S IN jack is used for Control S connection with a TV, the CONTROL S connection cannot be used for editing.

Operation (when recording on this VCR)

Before you start editing

- Turn on your TV and set it to the video channel.
- Press INPUT SELECT or CHANNEL +/- to display “L2” (or “L1”) in the display window.
- Press SP/EP to select the tape speed, SP or EP.

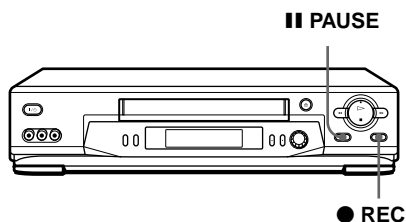

- 1** Insert a source tape with its safety tab removed into the other (playback) VCR. Search for the point to start playback and set it to playback pause.
- 2** Insert a tape into this (recording) VCR. Search for the point to start recording and press || PAUSE.
- 3** Press ● REC on this VCR to set it to recording pause.
- 4** To start editing, press the || PAUSE buttons on both VCRs at the same time.

To stop editing

Press the ■ STOP buttons on both VCRs.

Tip

- To cut out unwanted scenes while editing, press || PAUSE on this VCR when an unwanted scene begins. When it ends, press || PAUSE again to resume recording.

Note

- If you start recording following the procedure above, the VCR won't start recording with the APC function. To record a tape with the APC function, press ● REC again during recording pause in step 3 so that the VCR analyzes the tape. Then, press || PAUSE after the APC indicator stops flashing to start recording. If you press || PAUSE before the APC indicator stops flashing, the APC function is canceled.

General setup information

Setting the RF unit

When connecting the VCR to the TV using only the antenna cable, you must set the RF UNIT switch on the rear of the VCR so that the TV can receive the correct signal from the VCR.

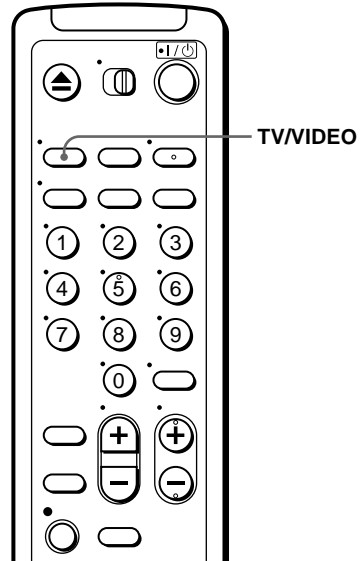
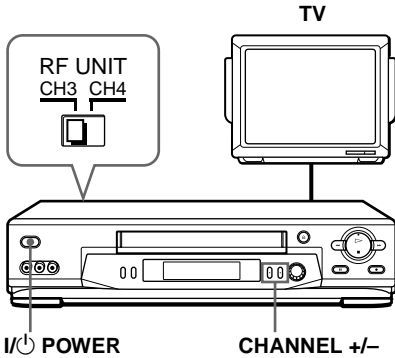

- 1** Set the RF UNIT switch on the rear of the VCR to CH3 or CH4, whichever channel is not used in your area. If both are used, set the switch to either channel.
- 2** Press I/⏻ POWER to turn on the VCR.
- 3** Press TV/VIDEO to turn on the VIDEO indicator in the VCR's display window.
- 4** Press CHANNEL +/- to display a channel number in the display window. Select an active channel number in your area.
- 5** Turn on your TV and set it to the channel you selected in step 1 (channel 3 or 4). The channel you selected in step 4 appears on the TV screen. If the channels change when you press CHANNEL +/-, you have made the correct setting. Whenever you use the VCR, set the TV to the channel selected in step 1.

Attaching the external antenna connector

When using a 300-ohm twin lead cable for a VHF/UHF antenna, use the EAC-32 antenna connector (not supplied) to connect the antenna to the VCR.

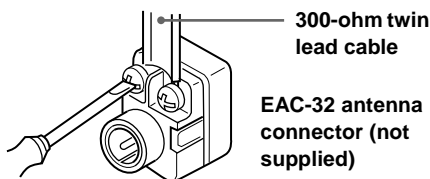

- 1** Loosen the screws on the antenna connector.
- 2** Wind the twin leads around the screws on the antenna connector.
- 3** Retighten the screws.

Attaching a UHF/VHF band mixer

When using both a 75-ohm coaxial cable and a 300-ohm twin lead cable for a VHF/UHF antenna, use the EAC-66 UHF/VHF band separator/mixer (not supplied) to connect the antenna to the VCR.

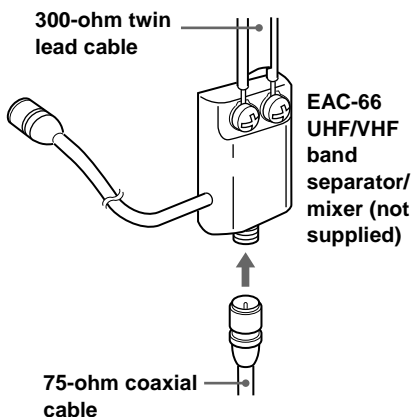

- 1** Loosen the screws on the mixer.
- 2** Wind the twin leads around the screws on the mixer.
- 3** Retighten the screws.
- 4** Connect the 75-ohm coaxial cable to the mixer.

Troubleshooting

If you have any questions or problems not covered below, please consult your nearest Sony dealer.

	Symptom	Remedy
Power	The I/⏻ switch does not function.	<ul style="list-style-type: none"> • Connect the AC power cord securely. • Make sure the VCR is not locked. To unlock, hold down I/⏻ POWER on the VCR until the 🔒 indicator disappears.
	The power is turned on but the VCR does not operate.	<ul style="list-style-type: none"> • Moisture condensation has occurred. Turn the power off, unplug the AC power cord and leave the VCR to dry for over three hours.
Clock	The clock has stopped and “-:-” appears in the display window.	<ul style="list-style-type: none"> • The clock stops if the VCR is disconnected from the wall outlet for more than one hour. Reset the clock (and timer).
	“ACS” flashes in the display window.	<ul style="list-style-type: none"> • The VCR is searching for a time signal. If channels in your area do not carry time signals, set the clock manually.
Playback	The playback picture does not appear on the TV screen.	<ul style="list-style-type: none"> • Make sure the TV is set to the channel for the VCR. If you are using a monitor, set it to video input.
	The picture is not clear.	<ul style="list-style-type: none"> • Adjust the tracking with the TRACKING +/- buttons. • The video heads are dirty (see the last page of “Troubleshooting”). Clean the video heads using the Sony T-25CLD or T-25CLDR video head cleaning cassette. If these cleaning cassettes are not available in your area, have the heads cleaned at your nearest Sony dealer (a standard service fee will be charged). Do not use a commercially available liquid type cleaning cassette, as it may damage the video heads. • The video heads may have to be replaced. Consult your local Sony dealer for more information.
	The picture rolls vertically during picture search.	<ul style="list-style-type: none"> • Adjust the vertical hold control on the TV or monitor.
	The picture has no sound.	<ul style="list-style-type: none"> • The tape is defective. • If you made A/V connections, check the audio cable connection.
Recording	A TV program does not appear on the TV screen.	<ul style="list-style-type: none"> • Make sure the TV is set to the channel for the VCR. If you are using a monitor, set it to video input. • Select the correct source with the INPUT SELECT or CH +/- buttons. Select a channel number when recording TV programs; select “L1” or “L2” when recording from other equipment.
	TV reception is poor.	<ul style="list-style-type: none"> • Adjust the TV antenna.
	The tape starts playing as soon as it is inserted.	<ul style="list-style-type: none"> • The safety tab has been removed. To record on this tape, cover the tab hole.
	The tape is ejected when you press ● REC.	<ul style="list-style-type: none"> • Check that the safety tab has not been removed.
	Nothing happens when you press ● REC.	<ul style="list-style-type: none"> • Make sure the tape is not at its end.

	Symptom	Remedy
Timer recording	The timer does not operate.	<ul style="list-style-type: none"> • Check that the clock is set. • Make sure a tape has been inserted. • Check that the safety tab has not been removed. • Make sure the tape is not at its end. • Make sure a program has been set for timer recording. • Make sure your timer settings are past the current time. • Check that the cable box is turned on. • The clock stops if the VCR is disconnected from the wall outlet for more than one hour. Reset the clock and timer. • When you use a Cable Mouse, make sure the CABLE BOX CONTROL option is set to ON (SLV-N81 only). • Turn the power off and unplug the AC power cord.
	A tape cannot be inserted.	<ul style="list-style-type: none"> • Check that a tape isn't already in the tape compartment.
Others	The remote commander does not function.	<ul style="list-style-type: none"> • Make sure you are pointing the remote commander at the remote sensor on the VCR. • Replace all the batteries in the remote commander with new ones if they are weak. • Make sure the •TV / VIDEO switch is set correctly. • If you are not using Control S, make sure that both miniplugs are disconnected.
	The channels on the VCR cannot be changed.	<ul style="list-style-type: none"> • Make sure the CABLE BOX CONTROL option is set to OFF.
	The tracking meter does not appear on the screen.	<ul style="list-style-type: none"> • The recording condition of the tape is very poor and tracking cannot be adjusted.
	You cannot control other TVs.	<ul style="list-style-type: none"> • Set your TV's code number. The code number may change when you replace the batteries of the remote commander.
	The VCR needs to be cleaned.	<ul style="list-style-type: none"> • Clean the cabinet, panel and controls with a dry, soft cloth, or a soft cloth slightly moistened with a mild detergent solution. Do not use any type of solvent, such as alcohol or benzine.

Symptoms caused by contaminated video heads

• Normal picture



• Rough picture



initial contamination

• Unclear picture



• No picture (or black & white screen appears)



terminal



Specifications

System

- Format
 - VHS NTSC standard
- Video recording system
 - Rotary head helical scanning FM system
- Video heads
 - Double azimuth four heads
- Video signal
 - NTSC color, EIA standards
- Tape speed
 - SP: 33.35 mm/s (1 $\frac{3}{8}$ inches/s)
 - EP: 11.11 mm/s ($\frac{7}{16}$ inches/s)
 - LP: 16.67 mm/s ($1\frac{1}{16}$ inches/s),
playback only
- Maximum recording/playback time
 - 8 hrs. in EP mode (with T-160 tape)
- Fast-forward and rewind time
 - Approx. 3 min. (with T-120 tape)

Tuner section

- Channel coverage
 - VHF 2 to 13
 - UHF 14 to 69
 - CATV A-8 to A-1, A to W, W+1 to W+84
- Antenna
 - 75-ohm antenna terminal for VHF/UHF

Inputs and outputs

- LINE-1 IN and -2 IN
 - VIDEO IN, phono jack (1 each)
Input signal: 1 Vp-p, 75 ohms, unbalanced, sync
negative
 - AUDIO IN, phono jacks (2 each)
Input level: 327 mVrms
Input impedance: more than 47 kilohms
- LINE OUT
 - VIDEO OUT, phono jack (1)
Output signal: 1 Vp-p, 75 ohms, unbalanced, sync
negative
 - AUDIO OUT, phono jacks (2)
Standard output: 327 mVrms
Load impedance: 47 kilohms
Output impedance: less than 10 kilohms
- CONTROL S IN (SLV-N81 only)
 - Mini jack (1)
- CABLE BOX CONTROL (CONTROL S OUT) (SLV-N81 only)
 - Stereo mini jack (plug in power) (1)

Timer section

- Clock
 - Quartz locked
- Timer indication
 - 12-hour cycle
- Timer setting
 - 8 programs (max.)
- Power back-up
 - Built-in self-charging capacitor
 - Back-up duration: up to 1 hour at a time

General

- Power requirements
 - 120 V AC, 60 Hz
- Power consumption
 - 22 W (SLV-N81)
 - 21 W (SLV-N71)
- Operating temperature
 - 5°C to 40°C (41°F to 104°F)
- Storage temperature
 - 20°C to 60°C (-4°F to 140°F)
- Dimensions
 - Approx. 430 × 97 × 292 mm (w/h/d)
(Approx. 17 × 3 $\frac{7}{8}$ × 11 $\frac{1}{2}$ inches) including
projecting parts and controls
- Mass
 - Approx. 4.1 kg (9 lb 1 oz)

Supplied accessories

- Remote commander (1)
- Size AA (R6) batteries (2)
- 75-ohm coaxial cable with F-type connectors (1)

Design and specifications are subject to change without notice.

ENERGY STAR® is a U.S. registered mark.

As an ENERGY STAR® Partner, Sony Corporation has determined that this product meets the ENERGY STAR® guidelines for energy efficiency.

Index to parts and controls

Refer to the pages indicated in parentheses () for details.

Front panel

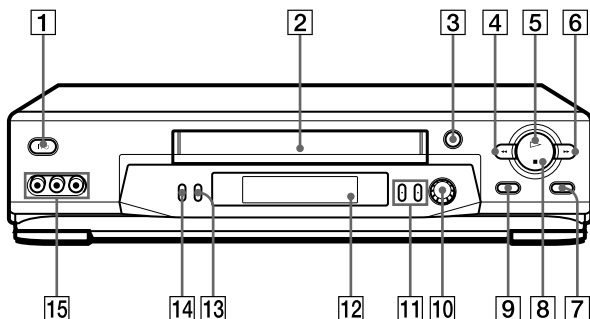

- | | |
|--|---|
| 1 I/⏻ POWER switch (71) | 9 ■■ PAUSE button (60) (95) |
| 2 Tape compartment | 10 DIAL TIMER (65) |
| 3 ▲ EJECT button (60) | 11 CHANNEL/TRACKING +/- buttons (63) (90) |
| 4 ◀◀ REW (rewind) button (60) (77) | 12 Remote sensor (7) |
| 5 ▷ PLAY button (60) (77) | 13 INPUT SELECT button (64) |
| 6 ▶▶ FF (fast-forward) button (60) (77) | 14 EASY SET UP button (13) (16) (19) (22) (25) |
| 7 ● REC (record) button (63) (79) (95) | 15 LINE-2 IN VIDEO/AUDIO L/R jacks (94) |
| 8 ■ STOP button (60) (95) | |

continued

Display window

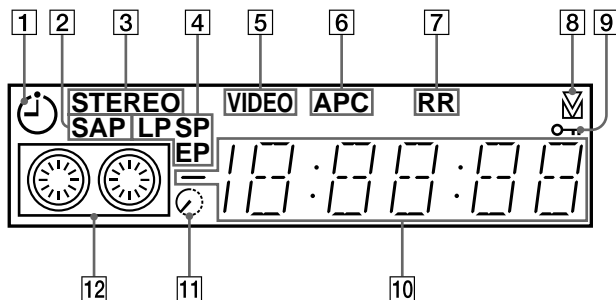

- | | |
|--|--|
| 1 Timer indicator (67) (71) (74) | 7 RR (Reality Regenerator) indicator (SLV-N81 only) (90) |
| 2 SAP (Second Audio Program) indicator (82) | 8 Tracking indicator (90) |
| 3 STEREO indicator (82) | 9 Child Lock indicator (76) |
| 4 Tape speed indicator (63) | 10 Time counter/clock/line/channel indicator (60) (63) (95) |
| 5 VIDEO indicator (64) (96) | 11 Remaining tape length indicator (63) |
| 6 APC (Adaptive Picture Control) indicator (91) | 12 Tape/recording indicator (63) |

Rear panel

SLV-N81

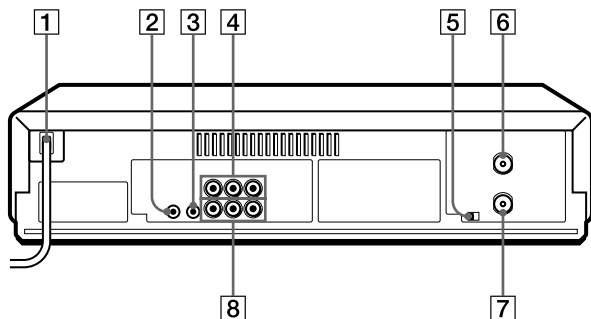

SLV-N71

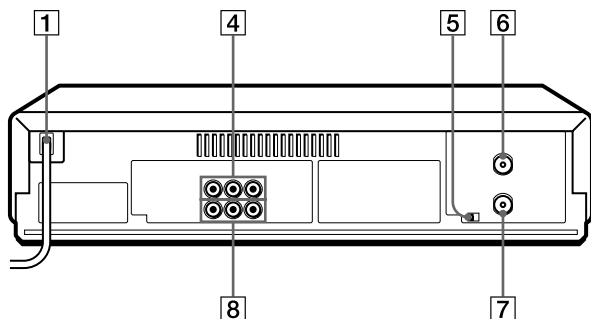

- | | |
|---|--|
| 1 AC power cord (9) | 5 RF (Radio Frequency) UNIT switch (96) |
| 2 CONTROL S IN jack (11) (94)
(SLV-N81 only) | 6 VHF/UHF IN connector (12) (15) (18)
(21) (24) |
| 3 CABLE BOX CONTROL (CONTROL S
OUT) jack (12) (15) (SLV-N81 only) | 7 VHF/UHF OUT connector (12) (15) (18)
(21) (24) |
| 4 LINE-1 IN AUDIO R/L/VIDEO jacks
(15) (94) | 8 LINE OUT AUDIO R/L/VIDEO jacks
(10) |

continued

Remote commander

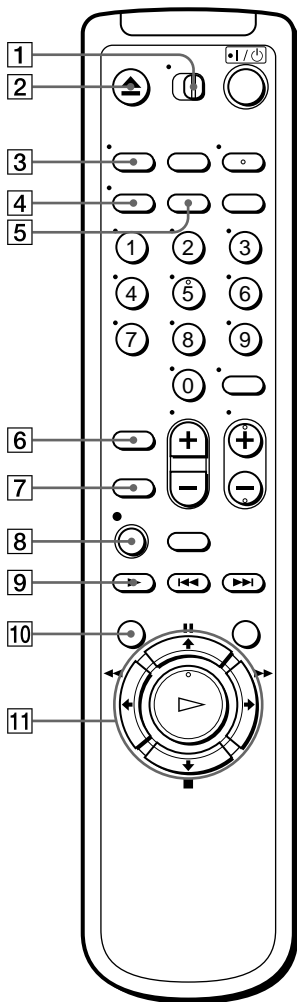

- 1** •TV / VIDEO switch (7)
 - 2** ▲ EJECT button (60)
 - 3** TV/VIDEO button (8) (64)
 - 4** DISPLAY button (63) (85)
 - 5** CLEAR button (60) (71) (81)
 - 6** SP (Standard Play)/EP (Extended Play) button (63)
 - 7** INPUT SELECT button (64) (95)
 - 8** ● REC (record) button (63) (79)
 - 9** ► SLOW button (77)
 - 10** MENU button (27) (92)
 - 11** || PAUSE/▲ button (27) (60)
- STOP/▼ button (27) (60)
 - ◀◀ REW (rewind)/ ◀ button (60) (77)
 - ▶▶ FF (fast-forward)/ ▶ button (60) (77)
 - ▷ PLAY/OK button (27) (60)

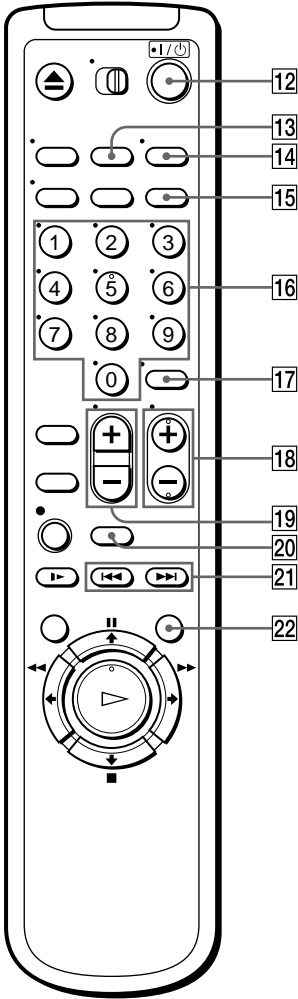

- 12** I/⏻ (power) switch (8) (71)
- 13** COUNTER/REMAIN button (63)
- 14** AUDIO MONITOR button (82)
- 15** VCR Plus+ button (70)
- 16** Number buttons (71)
- 17** ENTER button (71) (87) (88)
- 18** CH (channel) +/- buttons (8) (63)
- 19** VOL (volume) +/- buttons (8)
- 20** ×2 button (77)
- 21** ◀◀ / ▶▶ INDEX SEARCH buttons (84)
- 22** COMMERCIAL PASS button (60)

Index

A

- Adjusting
 - picture 46, 90
 - tracking 90
- Advanced option 92
- AFT (Auto Fine Tuning) 46
- Antenna hookup 21
- APC (Adaptive Picture Control) 91
- Audio track 83
- Audio/video (A/V) hookup 10
- Auto Clock Set 28
- Auto Tape Speed 92

C

- Cable box control
 - cable box code number
 - chart 37
 - setting 35
- Cable hookup 9
- Cable Mouse 12, 15
- Channel line-up chart 48, 55
- Child Lock 76
- Cleaning the video heads 98
- Clock setting 28
- Connecting
 - cable TV 12
 - external antenna connector 97
 - UHF/VHF band mixer 97
- Control S 11
- Counter 60

D

- Demonstration Mode 69
- Dial Timer 65
- Digital satellite receiver 15
- Disabling channels 44
- Dubbing. *see* Editing

E

- Easy Set Up 13, 16, 19, 22, 25
- Editing 94
- EP mode 63

F

- Favorite channel 88

H

- Hi-fi audio track 83

I

- Index search 84

L

- Language selecting 27
- Locking the VCR 76
- LP mode 64

M

- Monaural 82
- Monitoring audio during playback 82

N

- Normal audio track 83

P

- Picture adjustment. *see* Adjusting
- Playback 59
 - at various speeds 77
 - frame by frame 77
 - skip 60
 - slow motion 77
- Presetting channels 41

R

- Reality Regenerator 90
- Recording 62
 - bilingual programs 82
 - SAP broadcasts 82
 - saving 64
 - stereo broadcasts 82
 - timer setting 73
 - using Dial Timer 65
 - using VCR Plus+ or VCR Plus+ GOLD 70
 - while watching another program 64
- RF channel 96

S

- Safety tab 64

- SAP (Second Audio Program) 82

Searching

- at various speeds 77
 - for a selected point 85
 - using the index function 84
- Smart channel mapping 49
 - SP mode 63
 - Station ID 87
 - Stereo 82

T

- Timer setting 73
 - canceling 80
 - changing 80
 - checking 80
 - daily/weekly recording 75
 - using VCR Plus+ or VCR Plus+ GOLD 70
- Tracking adjustment. *see* Adjusting
- Tuner presetting 41

V

- VCR Plus+
 - channel set up 55
 - recording 70
- VCR Plus+ GOLD
 - channel set up 48
 - recording 70

Quick reference to using the VCR

Hookup 1 (SLV-N81 only)

To play a tape

- 1 Set the TV to channel 3 or 4 (or to video input, if you made A/V connections).
- 2 Insert a tape and press \triangleright PLAY.

To record a program

- 1 Turn on the cable box.
- 2 Press VCR Plus+ on the remote commander.
- 3 Enter the PlusCode number.
- 4 Select ONCE, DAILY, or WEEKLY, then press ENTER.
- 5 Insert a tape.
- 6 Press I/\odot to turn off the VCR.
- 7 Leave the cable box on.

To watch TV

- 1 Turn off your VCR, or press the VCR's TV/VIDEO button until the VIDEO indicator in the display window turns off.
- 2 Turn on your cable box.
- 3 Set the TV to the cable box output channel (usually 2, 3, or 4).
- 4 Set the cable box to the channel you want to watch.

Hookup 3

To play a tape

- 1 If you made A/V connections, set the TV to video input. If you didn't use A/V hookup:
 - Turn on the cable box.
 - Set the cable box to channel 3 or 4.
 - Set the TV to the output channel of the cable box (usually 2, 3, or 4).

- 2 Insert a tape and press \triangleright PLAY.

To record a program

- 1 Press VCR Plus+ on the remote commander.
- 2 Enter the PlusCode number.
- 3 Select ONCE, DAILY, or WEEKLY, then press ENTER.
- 4 Insert a tape.
- 5 Press I/\odot to turn off the VCR.

To watch TV

- 1 Turn off your VCR, or press the VCR's TV/VIDEO button until the VIDEO indicator in the display window turns off.
- 2 Select the channel with your cable box (if you have one) or with your TV.

Hookup 4

To play a tape

- 1 Set the TV to channel 3 or 4 (or to video input, if you made A/V connections).
- 2 Insert a tape and press \triangleright PLAY. If there's no picture on your TV, press the VCR's TV/VIDEO button until the VIDEO indicator appears in the display window.

To record a program

- 1 Press VCR Plus+ on the remote commander.
- 2 Enter the PlusCode number.
- 3 Select ONCE, DAILY, or WEEKLY, then press ENTER.
- 4 Insert a tape.
- 5 Press I/\odot to turn off the VCR.

To watch TV

- 1 Turn off the VCR, or press the VCR's TV/VIDEO button until the VIDEO indicator in the display window turns off.
- 2 Set the TV to the channel you want to watch.

Hookup 5

To play a tape

- 1 Set the TV to channel 3 or 4 (or to video input, if you made A/V connections).
- 2 Insert a tape and press \triangleright PLAY.

To record a program

- 1 Turn on the cable box.
- 2 Set the cable box to the channel you want to record.
- 3 Press VCR Plus+ on the remote commander.
- 4 Enter the PlusCode number.
- 5 Select ONCE, DAILY, or WEEKLY, then press ENTER.
- 6 Insert a tape.
- 7 Press I/\odot to turn off the VCR.
- 8 Leave the cable box on.

To watch TV

- 1 Turn off your VCR, or press the VCR's TV/VIDEO button until the VIDEO indicator in the display window turns off.
- 2 Turn on your cable box.
- 3 Set the TV to the cable box output channel (usually 2, 3, or 4).
- 4 Set the cable box to the channel you want to watch.

Sony  line

<http://www.world.sony.com/>